



Spectrum and Energy Efficiency in 5G Mobile Data Networks

Ender Ayanoglu
UC Irvine EECS/CPCC

05/20/2019
IEEE International Conference on Communications

This tutorial is based on the paper



Quantifying Potential Energy Efficiency Gain in Green Cellular Wireless Networks

Kemal Davaslioglu *Student Member, IEEE* and Ender Ayanoglu *Fellow, IEEE*

- Published in ***IEEE Communications Surveys and Tutorials***
- Available from ***IEEE Xplore***
- Vol. 16, pp. 2065-2091, Fourth Quarter 2014
- DOI 10.1109/COMST.2014.2322951
- It is both a survey and a tutorial
- Has 28 pages of material, much longer than a typical ***IEEE Transactions*** paper



Computing and Communications in About Six Decades

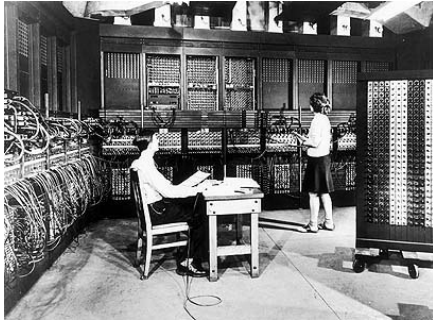

- Development of Information and Communication Technologies (ICT) within last few decades has
 - Improved our lives tremendously
 - Made information highly accessible
 - Increased productivity to unprecedented levels
 - Created enormous wealth



Made Possible by Moore's Law

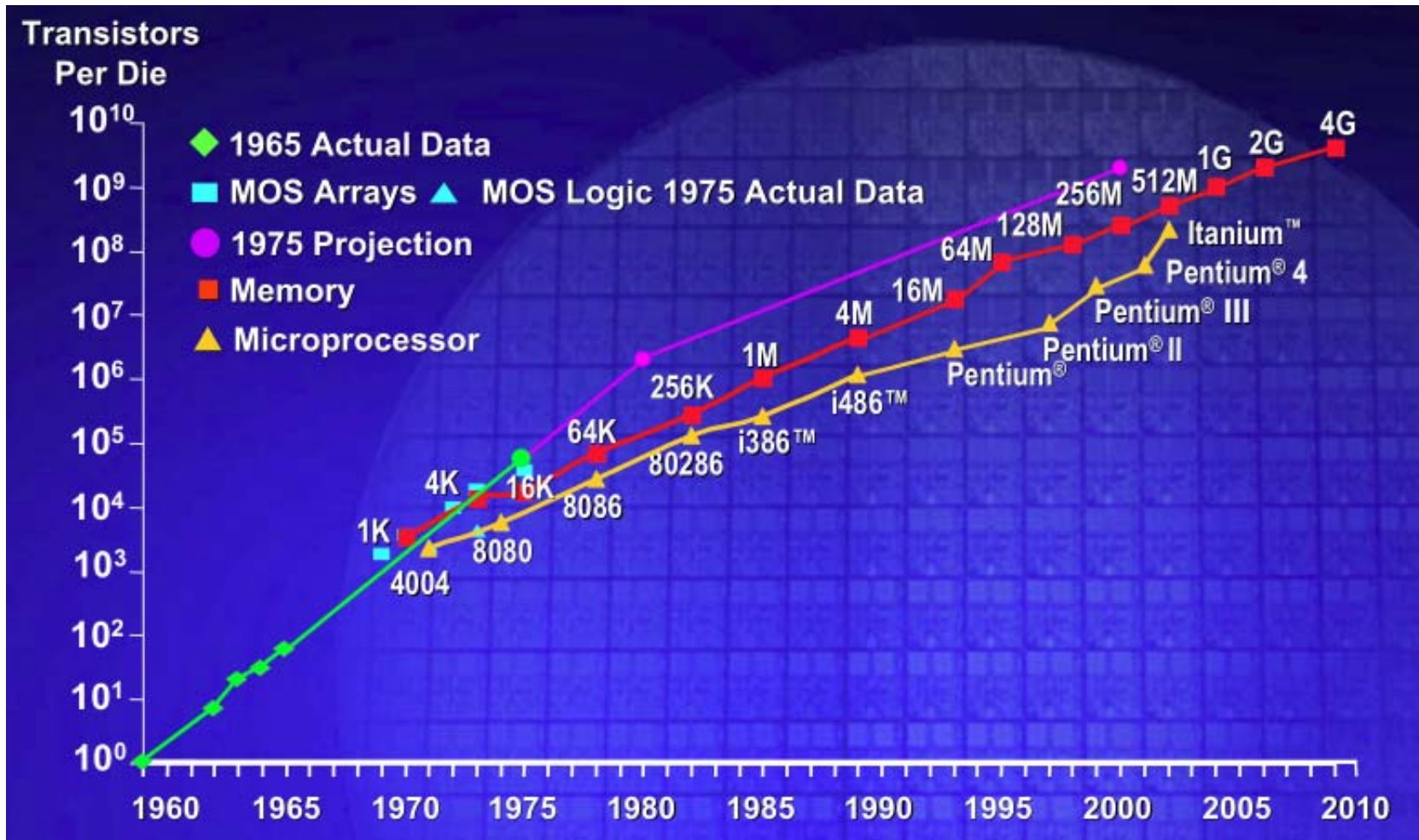

Kurzweil's Extension of Moore's Law

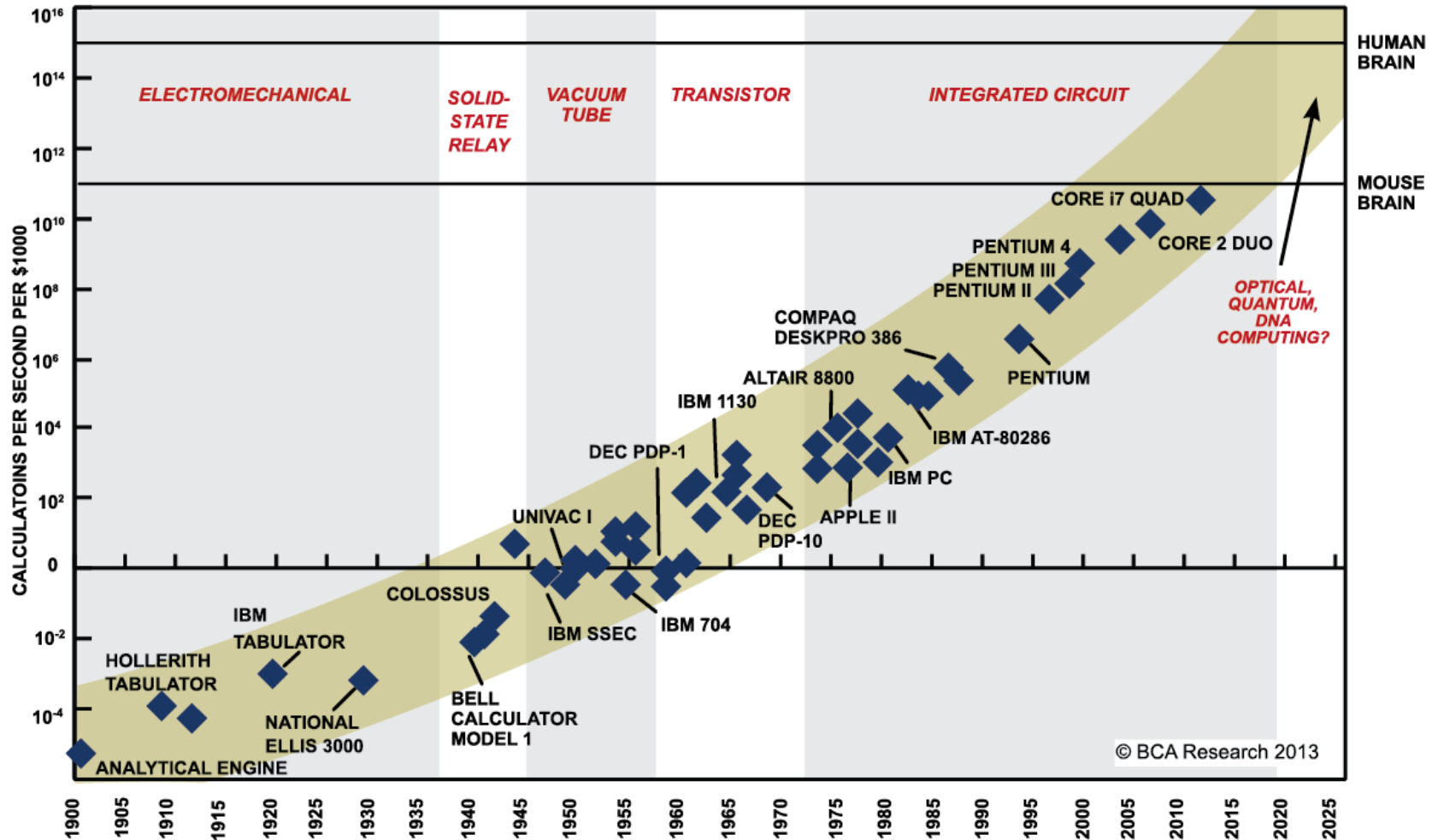

© BCA Research 2013

SOURCE: RAY KURZWEIL, "THE SINGULARITY IS NEAR: WHEN HUMANS TRANSCEND BIOLOGY", P.67, THE VIKING PRESS, 2006. DATAPPOINTS BETWEEN 2000 AND 2012 REPRESENT BCA ESTIMATES.



This Has a Very High Cost



- ICT industry is responsible from 2-4% of all Carbon footprint generated by human activity
- This is equal to about 25% of all car emissions
- Or, about all airplane emissions!



It Will Only Get Worse

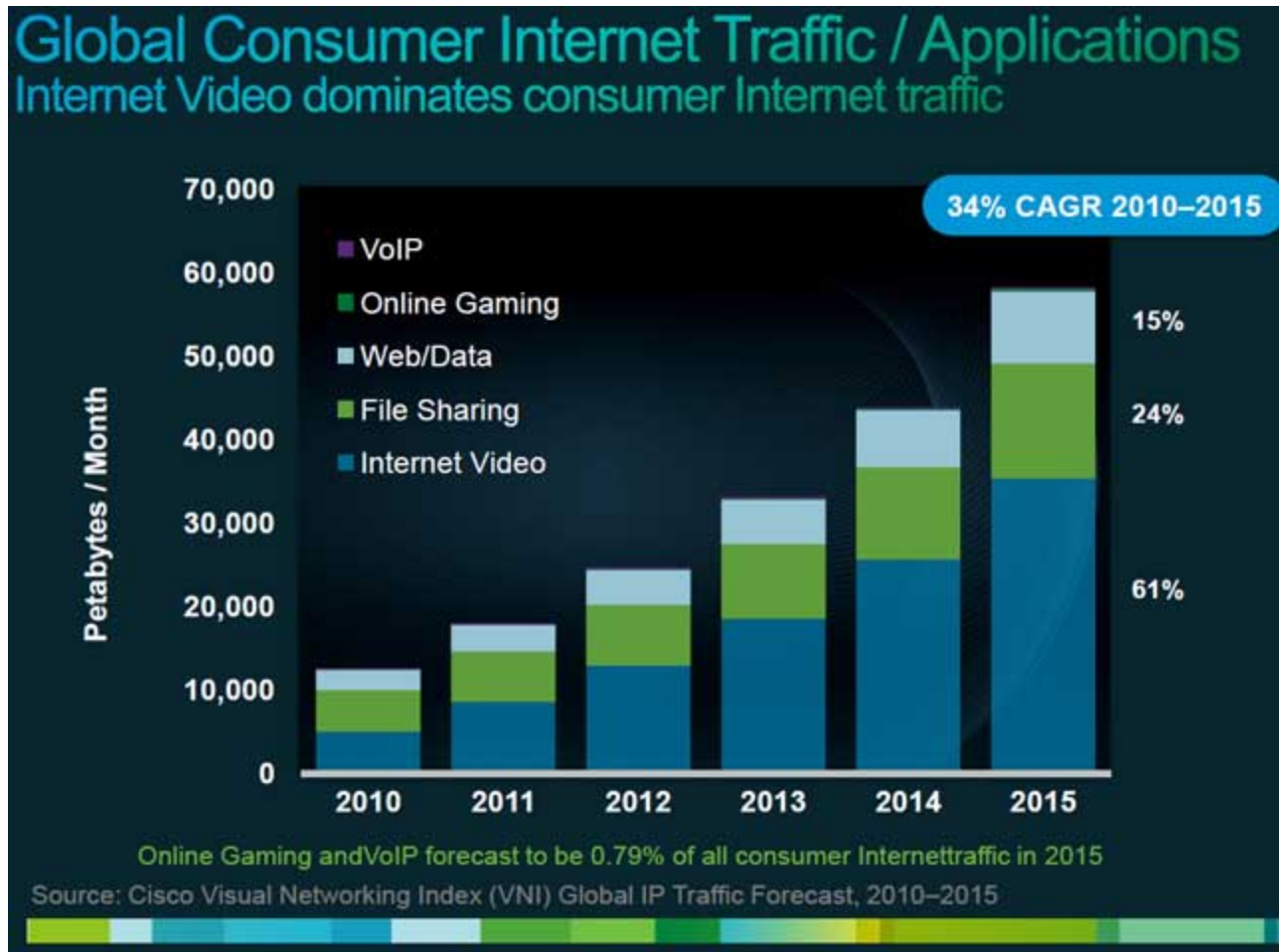

- Still close to the estimates of 40-50% increase per year of '90s



Mobile Data Will Increase More Than Internet

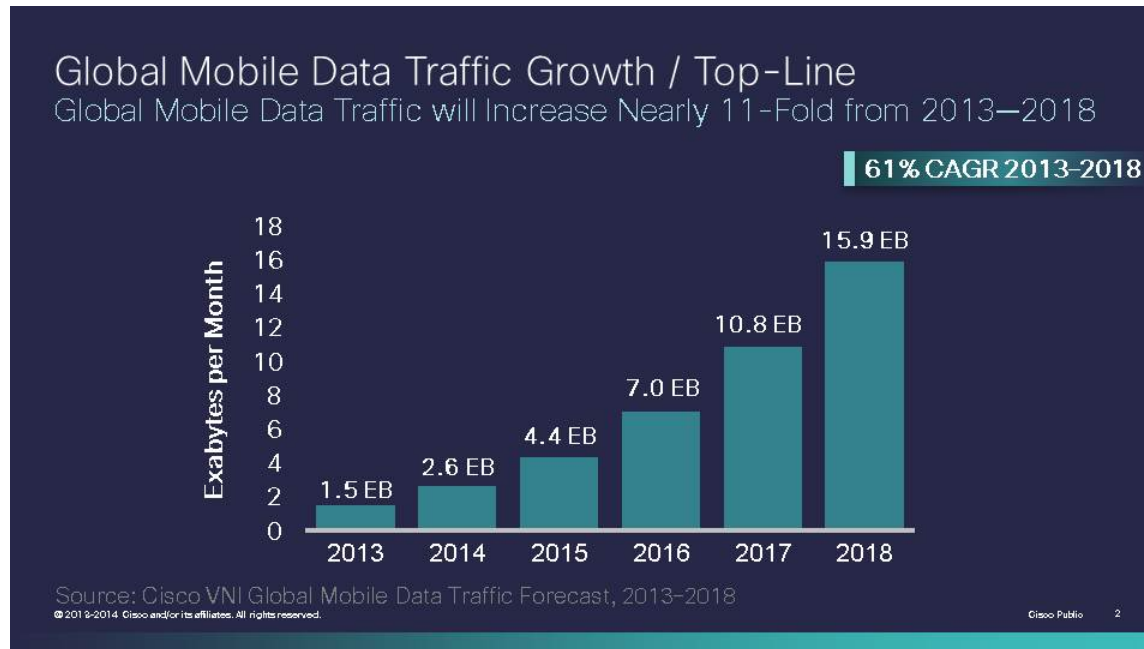

- A Cisco study quoted that the expected Compound Annual Growth Rate (CAGR) in mobile data during 2013-2018 is 61%
- Even bigger growth rates have been observed
 - UK-based Telefonica O2 reported its mobile traffic in Europe doubled every 3 months in 2009
 - Telecom Italia mobile traffic grew 216% from mid-'08 until mid-09
 - AT&T reported its mobile traffic increased 5000% '08-'10



Video in Mobile Data

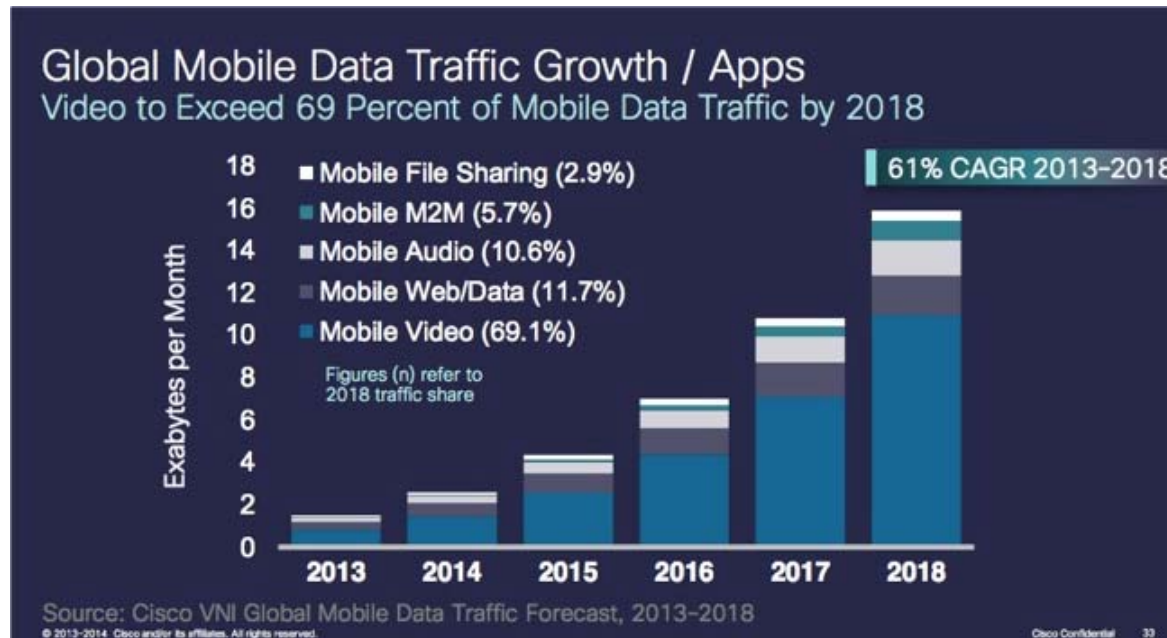

- About 2/3 of mobile data is expected to be due to video (surprise!)
- Development of smart phones and social networking changed the picture
- Average smart phone generates 50x the amount of traffic generated by a basic mobile phone
- This number is 120x and 368x for tablets and laptops
- E-readers, wireless video cameras, laptop computers, mobile video projectors will also contribute



Green Communications

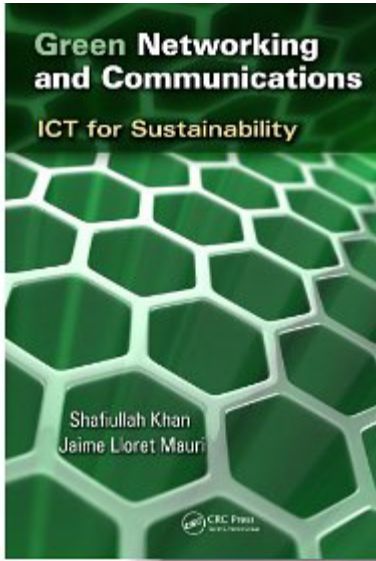

- A major impetus in research



Major ICT Manufacturers



..... Alcatel-Lucent 

**GREEN
INFORMATION
COMMUNICATIONS
TECHNOLOGY**

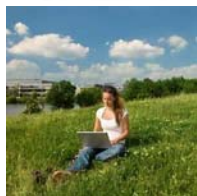

Network Energy Efficiency:
Cisco Review and Results



Cisco EnergyWise: The Network as the Platform for Energy Management and Cost Savings



GreenTouch™



**ERICSSON
ENERGY AND
CARBON
REPORT**

ON THE IMPACT OF THE NETWORKED SOCIETY

Digital Ideas



GreenTouch & Alcatel-Lucent Save Energy in Wireline
GreenTouch Consortium aims to improve the energy efficiency of information & communications technology (ICT) networks by a factor of 1,000. Bell Labs researcher Peter Vetter and Michael Peeters, CTO Alcatel-Lucent Wireline discuss the second major GreenTouch milestone which includes a power reduction that is the equivalent of taking some half a million cars off the road!



- Alcatel-Lucent is leading a consortium, partners from industry and academia: Reduce power consumption in ICT by 3 orders of magnitude
- Cisco, Ericsson, Huawei all have efforts for Green Communications



Example: Make IEEE 802.3 Energy Efficient



The infographic is titled "IEEE 802.3™ ETHERNET STANDARDS MILESTONES" and is presented by the IEEE Standards Association. It features a large "30 YEARS OF ETHERNET STANDARDS" graphic on the left, with a globe icon. The main content is a vertical timeline of milestones from 1973 to 2012. On the right, there are four categories: Social, Transactions, Work, and Information Access, each with representative images. Below these is a section titled "Ethernet-Enabled Communications" with a grid of icons for various applications like Medical Imaging, Automotive, Retail, Routers, Servers, and High Def Media.

IEEE STANDARDS ASSOCIATION IEEE

IEEE 802.3™ ETHERNET STANDARDS MILESTONES

- 28 December 2012 | 2012 Revision of Ethernet Std
- 30 September 2010 | Energy-efficient Ethernet
- 17 June 2010 | 40Gb/s and 100Gb/s Ethernet
- 22 March 2007 | Backplane Ethernet
- 6 April 2005 | Ethernet In First Mile
- 12 June 2003 | Power over Ethernet
- 13 June 2002 | 10Gb/s Ethernet
- 30 March 2000 | Link Aggregation
- 25 June 1998 | 1000Mb/s Ethernet
- 20 March 1997 | Full Duplex Ethernet
- 14 June 1995 | 100Mb/s Ethernet
- 28 September 1990 | 10BASE-T
- 10 December 1987 | 10Mb/s Fiber (FOIRL)
- 12 December 1985 | 10Mb/s Repeater
- 23 June 1983 | 10Mb/s Ethernet
- 23 June 1983 | IEEE 802.3 first approved as an IEEE standard
- 22 May 1973 | Ethernet Invented

30 YEARS OF ETHERNET STANDARDS

2013 is the 30th Anniversary of IEEE 802.3 Ethernet Standards.

Did you know how much Ethernet impacts our lives every day no matter where we are in the world? With more than 12 billion ports deployed in 2012 alone, Ethernet is a technology that impacts day-to-day life globally. The IEEE 802.3 Ethernet standard is the foundation for today's world of high-speed communications. Ethernet touches a tremendous range of established and emerging technologies, including data-center networks, personal computers, laptops, tablets, smartphones, subscribe access, cellular backhaul, power infrastructure and smart meters, personal medical devices, the Internet of Things and connected cars.

For more information on the IEEE 802.3 Ethernet standards that help transform the way we communicate in our personal lives, at work and at play, visit: standards.ieee.org/events/ethernet

Social **Transactions**

Work **Information Access**

Ethernet-Enabled Communications

LIVE	WORK	PLAY
Medical Imaging	Enterprise	Gaming
Automotive	Email	Television
Retail	Cloud	Social Media
Routers	Server	High Def Media

- IEEE 802.3 is the Ethernet protocol
- It is used to network PCs, servers, and various peripherals
- Operates at speeds of 10, 100 Mb/s, 1, 10 Gb/s
- Designed to transmit physical layer signals even when there is no information to be transferred. This is wasteful with bursty data.



IEEE 802.3az Protocol

- Periodically transmit LPI indication signal
- Let TX chips to be turned off
- When there is data to transmit a normal idle signal is sent to wake the TX system up before data is due to be sent
- The data link is considered to be always operational as the RX circuit remains active even when the TX path is in sleep mode
- Savings expected to rise to \$410M/year for the US and \$1B/year worldwide

A link that is not transmitting enters the Low Power Idle (LPI) state to save power. Energy-Efficient Ethernet reduces the energy consumption by 30%.



Sources of Energy Inefficiency in Cellular Wireless Networks

MTCO₂e: Metric Tonne (Ton) CO₂ Equivalent



	ICT (excluding PCs, servers, etc.)	Cellular Networks	Mobile Phones
2002	151	64 (42%)	16 (11%)
2020	349	179 (51%)	22 (6%)

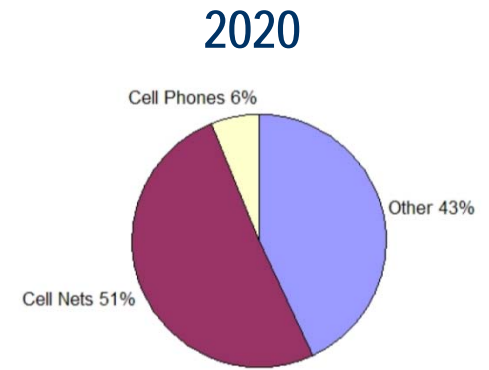
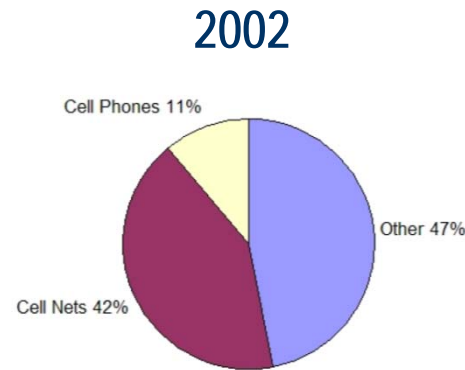

- The contribution due to cellular networks and mobile phones will more than double from '02 to '20
- This contribution is increasing in relative terms
- The contribution due to cellular networks is far greater than that of mobile phones



80% of the Total Power in Cellular Networks is in Radio Base Station (RBS)



- Furthermore,

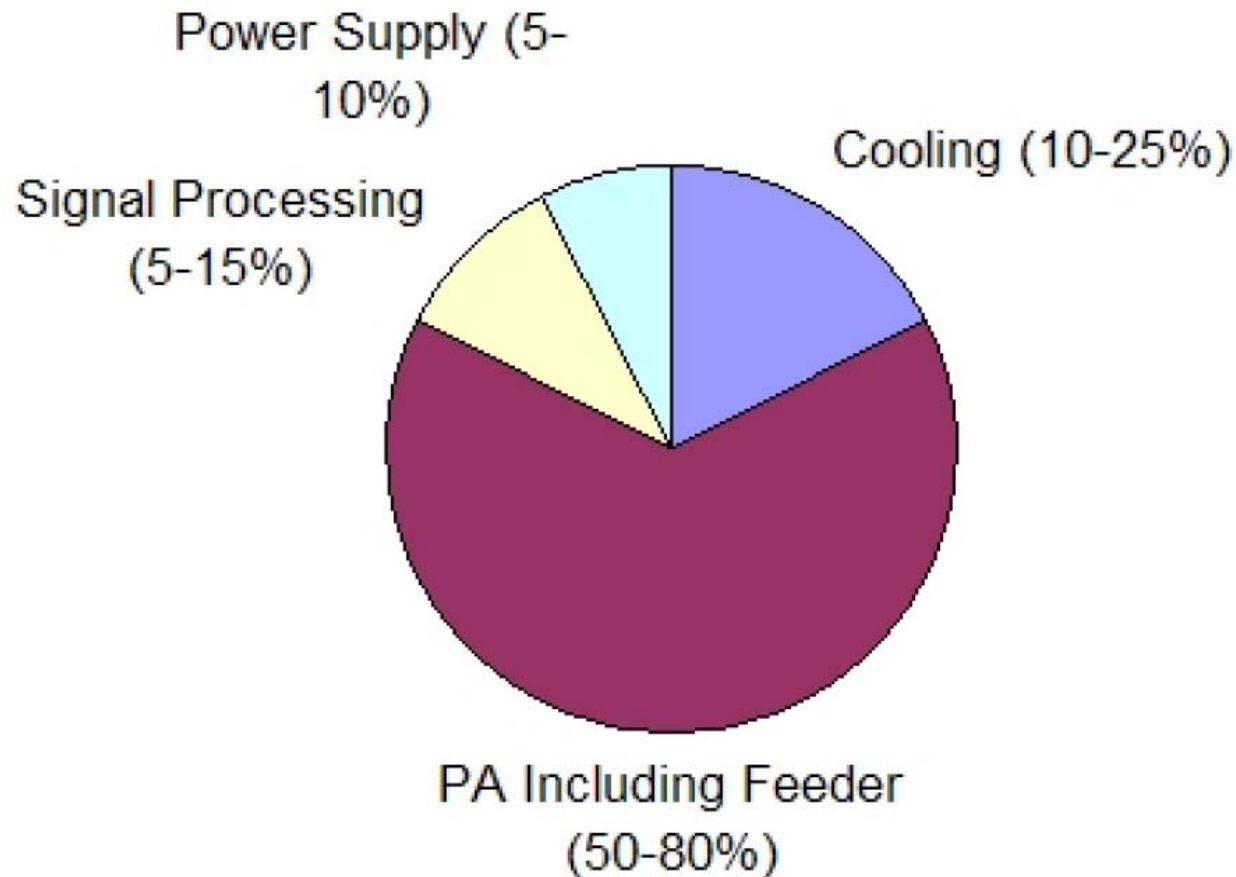

RBSs Need to Be Redesigned



- Concentrate on RBS since it is most energy-inefficient
- Higher throughput makes conventional RBSs operate in an inefficient mode
- Newer technologies promise higher transmission speeds at higher distances
- These require operation in a linear mode
- This mode is highly inefficient and consumes a lot of power

Generations of Cellular Wireless



- **1G: Analog voice**
 - AMPS, NAMPS (US), NMT 450, NMT 900 (Eu), N-TACS (J)
- **2G: Digital voice**
 - TDMA: Time Division Multiple Access
 - US IS-136
 - GSM (Global System for Mobile Communications, originally Groupe Spécial Mobile)
 - Japan PDC
 - CDMA: Code Division Multiple Access IS-95
- **2.5G: Evolution to 3G**
 - GPRS (Global Packet Radio Service), EDGE (Enhanced Data GSM Environment)



Evolution to 3G

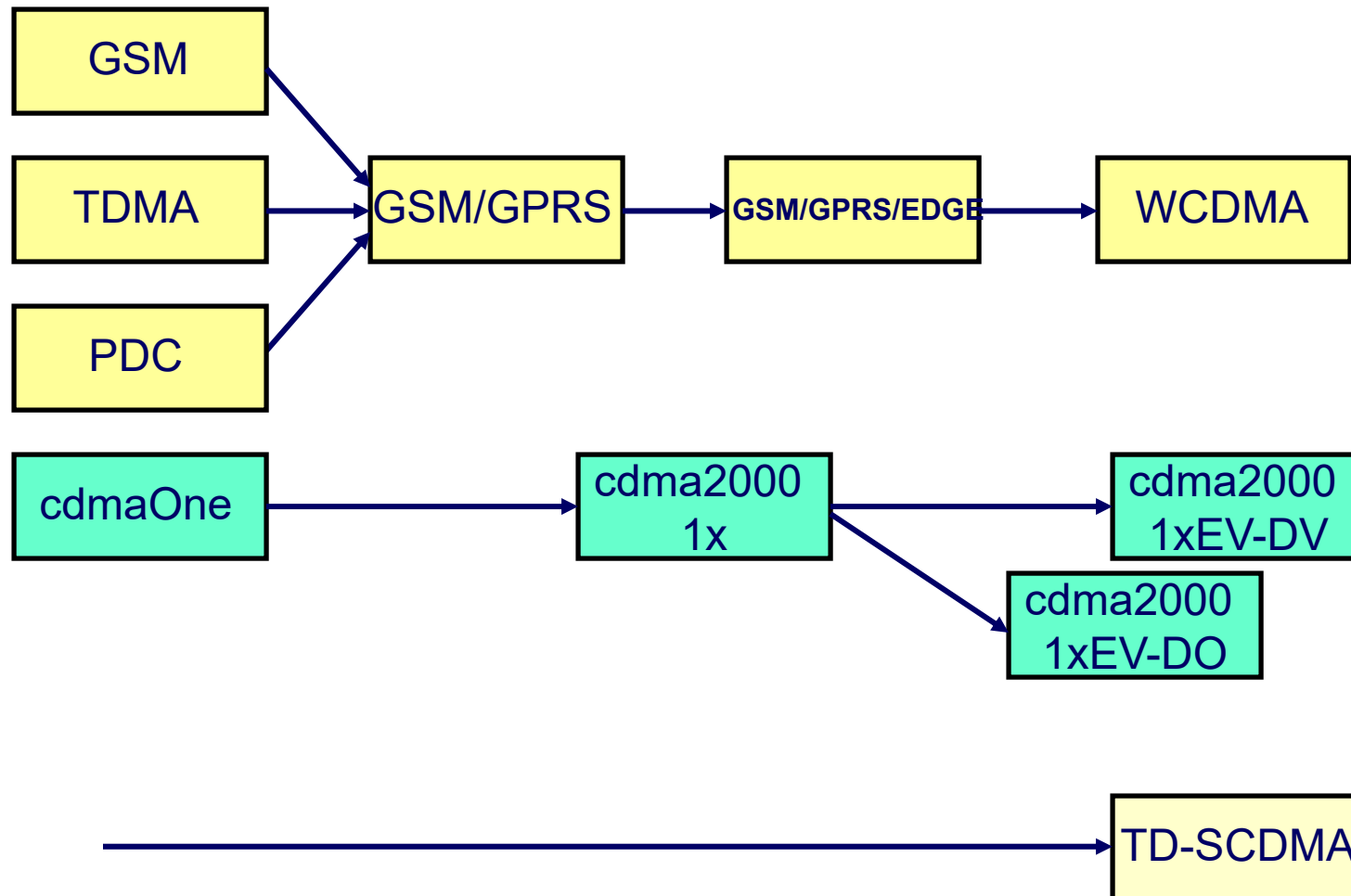

Generations of Cellular Wireless



- 3G: Data rides on digital voice
 - GSM evolved into Wideband CDMA (W-CDMA)
 - CDMA evolved into cdma2000
- 4G: Everything transmitted in packetized data
 - WiMAX (IEEE 802.16) was proposed but did not gain acceptance
 - W-CDMA evolved into LTE (Long Term Evolution)
 - CDMA proposed UMB (Ultra-Mobile Broadband) but dropped
- 5G: Being considered for 2020. What it will be is in discussion



LTE Employs Orthogonal Frequency Division Multiplexing (OFDM)

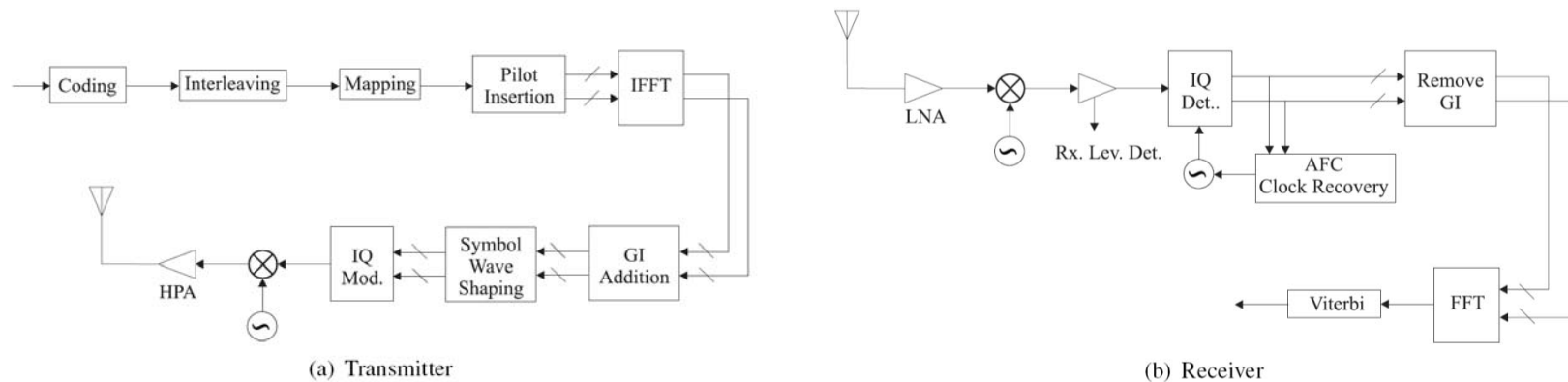

- Employs IFFT and FFT to translate the transmitted message into the frequency domain
- Estimates the frequency response of the channel and equalizes the channel in the frequency domain
- Best technique for broadband frequency selective channels
- Employed in 801.11a/g, ADSL, DAB, DVB, etc
- Has high Peak-to-Average Power Ratio (PAPR)



LTE Downlink Transmission Rates

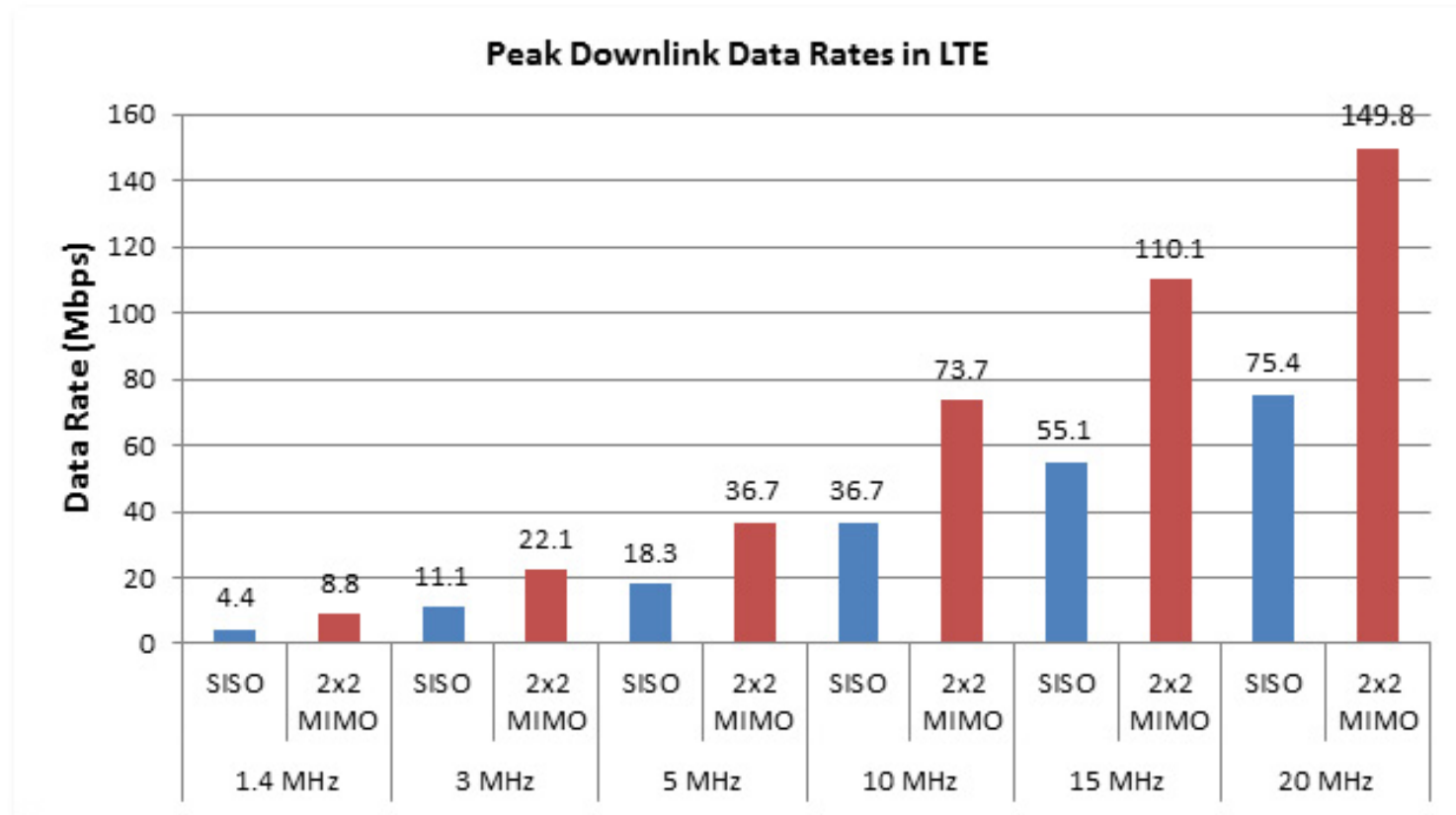

- 3G has a maximum downlink transmission rate of about 10 Mb/s
- LTE rates are much higher, about an order of magnitude higher



LTE-Advanced Downlink Transmission Rates



		Release 8 LTE	LTE-Advanced	IMT-Advanced target
Peak data rate	Downlink	300 Mbps	1 Gbps	1 Gbps*
	Uplink	75 Mbps	500 Mbps	
Peak spectrum efficiency [bps/Hz]	Downlink	15 (4x4 MIMO)	30 (up to 8x8 MIMO)	15 (4x4 MIMO)
	Uplink	3.75 (64QAM SISO)	15 (up to 4x4 MIMO)	6.75 (2x4 MIMO)

*100 Mbps for high mobility and 1 Gbps for low mobility

- LTE-Advanced targets even higher rates
- But, offering OFDM via legacy RBSs covering a range of a few kms at 10s or even 100s of Mb/s is questionable, especially from an energy efficiency viewpoint
- This push will enormously increase energy consumption in cellular wireless systems, which is already at alarmingly high levels



Power Amplifier Transfer Function and Power Backoff

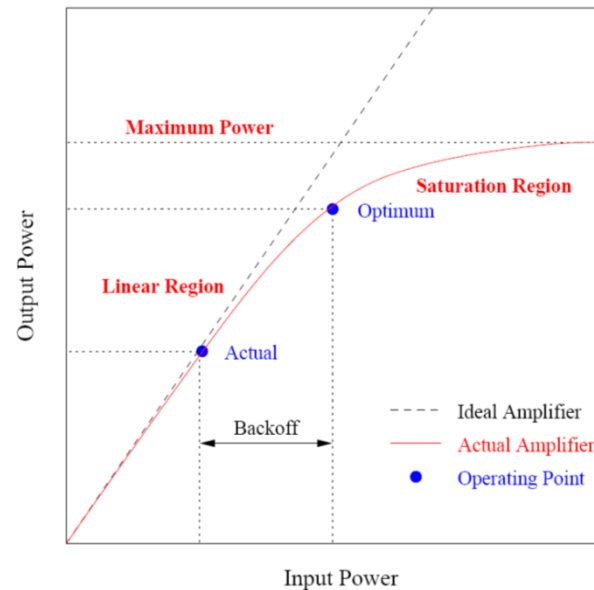

- When the signal has PAPR, the operating point needs to be backed off by an equal amount
- PAPR increases substantially with LTE and LTE-Advanced since FFT size increases from about $N = 64$ to $N = 2048$
- Worst case PAPR is $10 \log_{10} N$
- Actual value is less than the worst case but still increases with N



Best Modulation Technique?



- OFDM is desirable because of making simple equalization possible
- It suffers from PAPR
- Modulation techniques that do not suffer from PAPR have constant envelope
- Most constant envelope modulation techniques have low transmission rates
- Is it possible to combine the combine the advantages of OFDM and constant envelope?



Cell Deployment

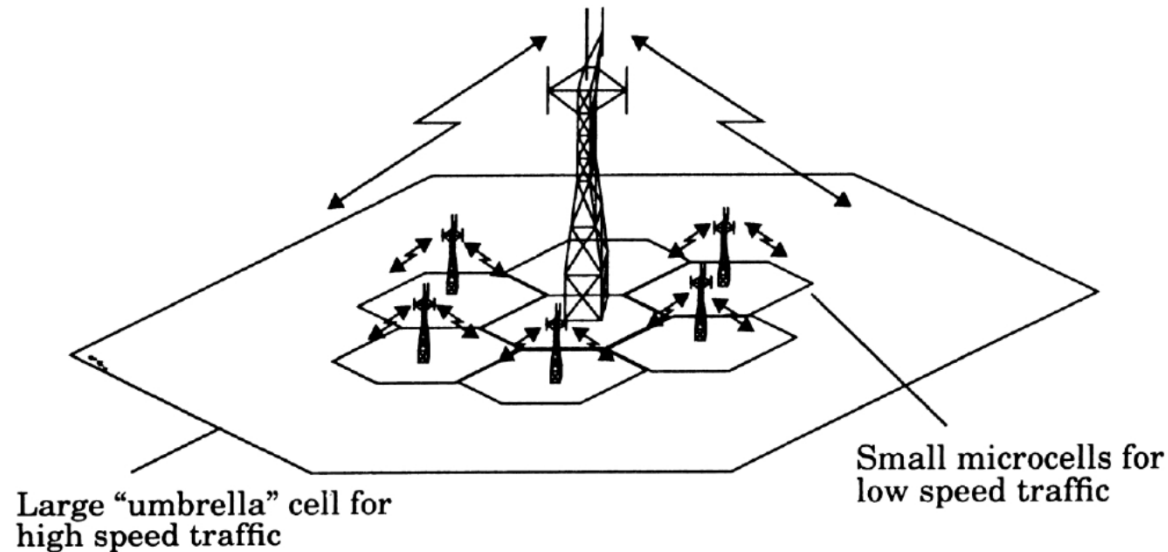

- Current cellular network architecture is based on a single-tier architecture
- It was designed to support mobile users with telephony
- Increasingly, users with much lower or no mobility demand much higher rates
- This calls for a new architecture: A two-tier network with small cells

Weekly and Daily Variations in Cellular Traffic

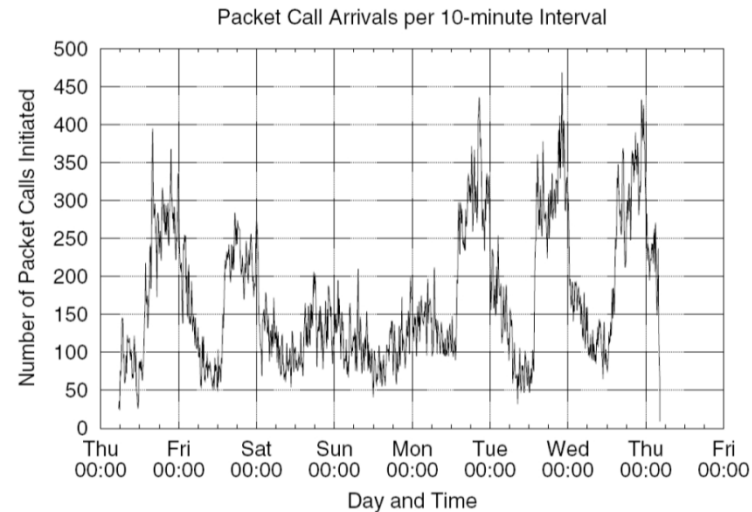

- Cellular traffic shows a great deal of variation according to the day of the week and the time of the day
- Heavier traffic occurs during weekdays as opposed to weekends
- Heavier traffic occurs during afternoons and early evenings (different than wired Internet which follows business hours)
- Heaviest to lightest traffic volume is measured to be 2-6



Exploit Variations in Traffic for Energy Efficiency

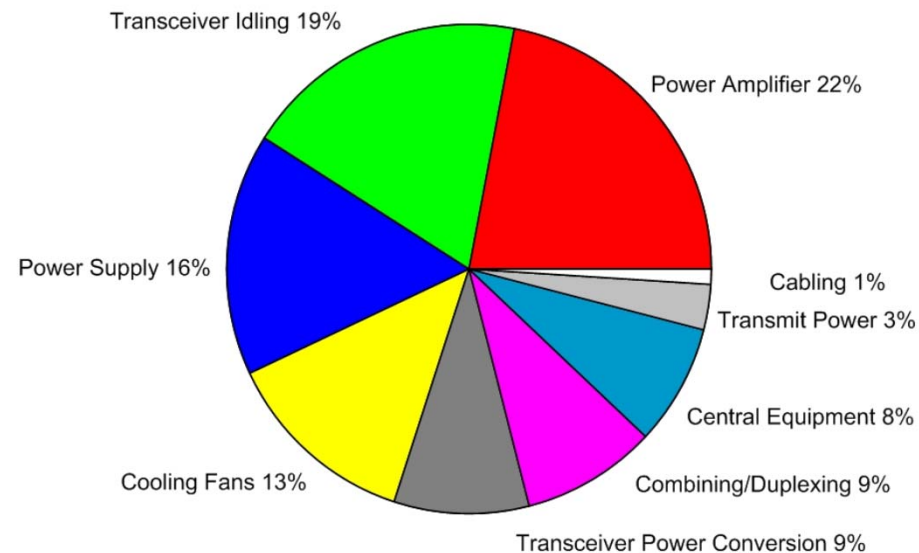

- Transceiver idling consists of about 19% of the energy use
- Exploiting heavy to light traffic variations can lead to significant energy savings
- This can be done by turning off parts of base stations during times of low traffic
- In addition, there is variation with respect to location. About 10% of sites carry 50% of traffic, about 50% of sites carry 5% of traffic. This difference is also not exploited



RBS Energy Consumption



- A typical 3G RBS consumes 500W for 40W output (8% efficiency)
- This corresponds to 4.4 MWh annual energy consumption
- There were about 52.5K RBSs in UK in 2009
- This means 230 GWh per year in UK
- This is equal to 165K MtCO₂, or equivalent to 31.5K cars
- In the US, this number is 750K cars, in China, 421K cars
- Note with OFDM, the efficiency figure will actually go down

What It Means for the Service Provider

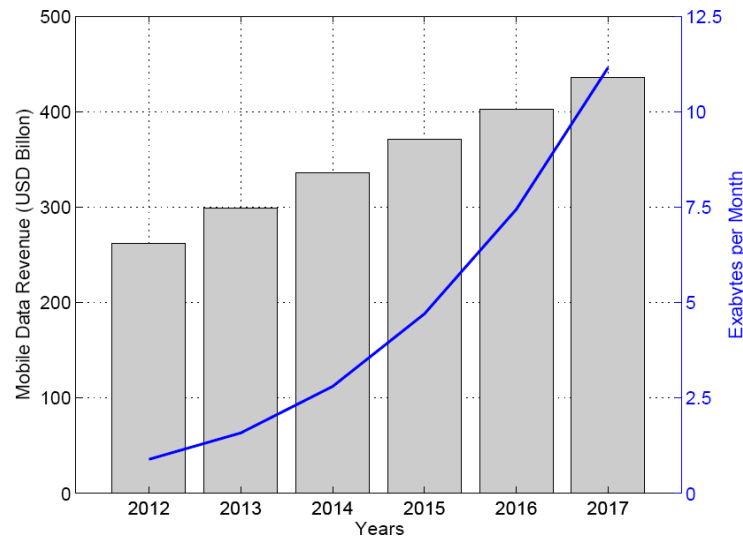

- The expected yearly growth rate for wireless data is 61%
- Expected global data revenue increase is much less, about 6-11%
- The growth in demand is exponential whereas revenue increase is almost linear
- Service providers strive to reduce operational expenses (OpEx)
- Therefore, energy efficiency is very important for service providers



Methods for Energy Efficiency in Cellular Wireless Networks

Constant-Envelope OFDM

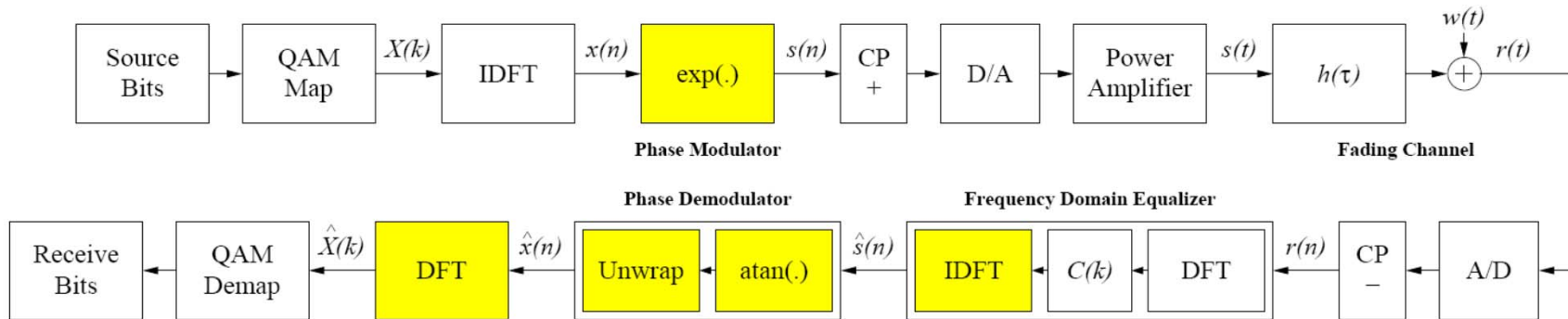

Transmitter:

- The input sequence $X[k]$ is complex-valued, a conjugate symmetric version of it is generated
- After going through IDFT, a real-valued sequence $s[n] = \exp(jCx[n])$ is generated
- As in OFDM, a cyclic prefix is added
- The signal is then transmitted



CE-OFDM

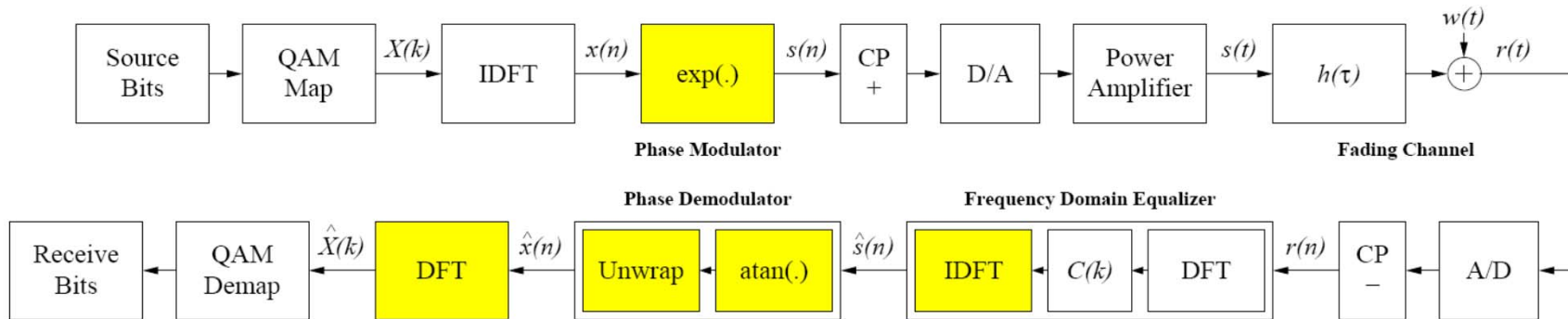

Receiver:

- Cyclic prefix is removed
- DFT is performed and frequency domain equalization is carried out
- In order to get back to $X[k]$, an IDFT is performed, then $\text{atan}()$ of the sequence is calculated
- With another DFT, $X[k]$ is recovered



CE-OFDM Signal

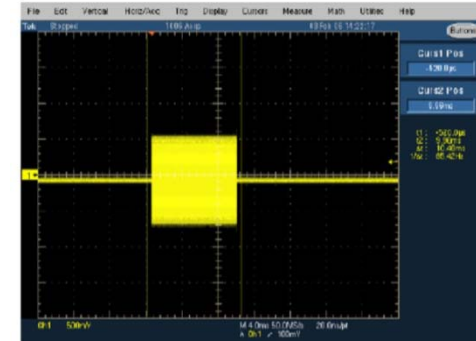
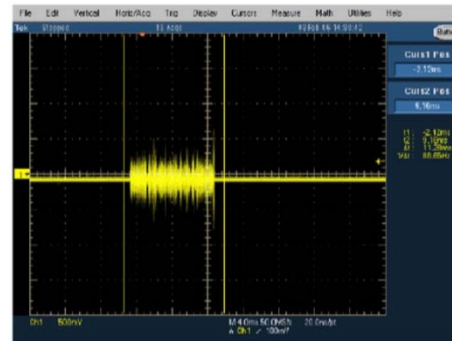
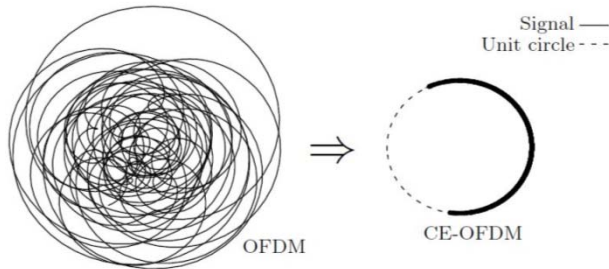

- After the IDFT, the OFDM signal has varying magnitudes
- After the transformation $s[n] = \exp(jC_x[n])$, the complex-valued sequence has unit magnitude and the information content is transformed to the phase of $s[n]$
- The resulting signal has no PAPR
- An implementation was carried out using FPGAs, a microprocessor, and a DSP chip



OFDM and CE-OFDM PAPR Simulations

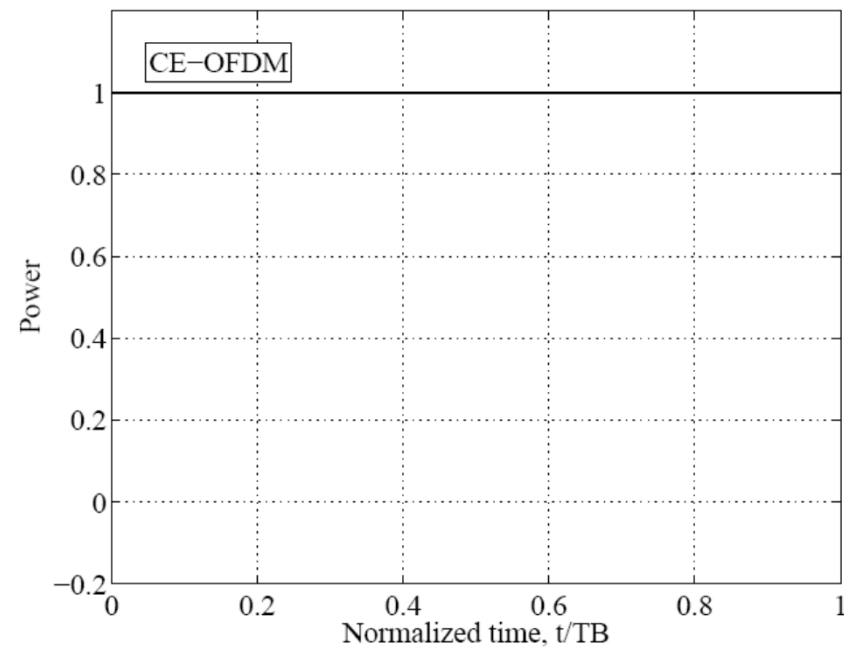
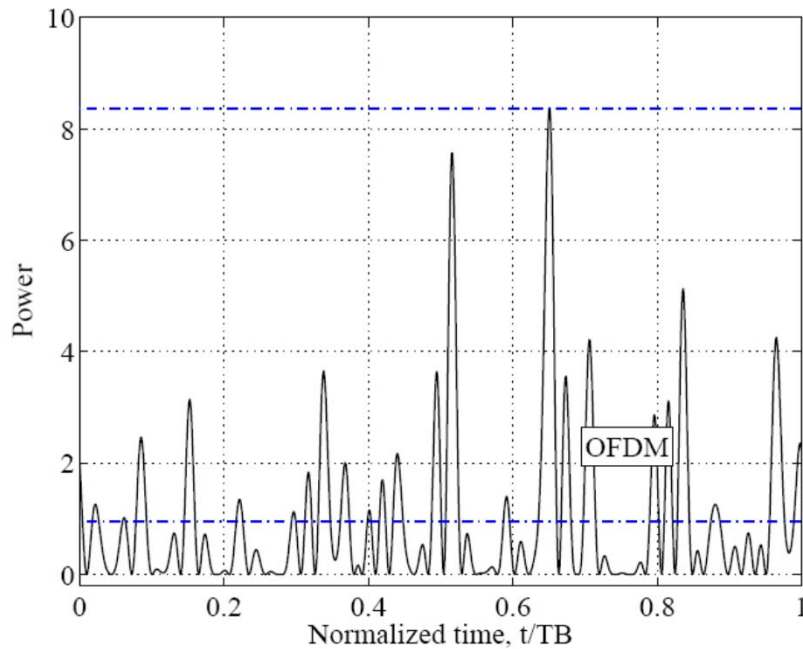

- Simulations show OFDM has large PAPR while CE-OFDM has none



CE-OFDM Advantages and Disadvantages



- It has been shown via simulations that CE-OFDM has better BER characteristics than OFDM when used with realistic power amplifier models and realistic backoff values for both AWGN and fading channels
- CE-OFDM has better fractional out-of-band power when compared to OFDM

CE-OFDM is promising. However, more work needs to be done

- Its bandwidth tradeoff needs to be quantified
- Phase unwrapping in the presence of noise worsens BER performance. Can be improved with oversampling but needs a study
- It may be possible to improve the BER performance at low SNR
- Coded CE-OFDM needs to be studied



Class J Power Amplifiers

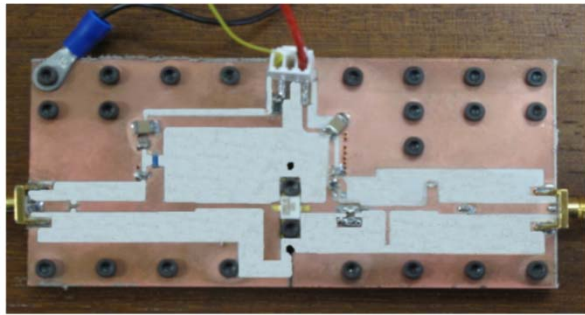

Tuffy et al., *IEEE MTT-S*, 2011

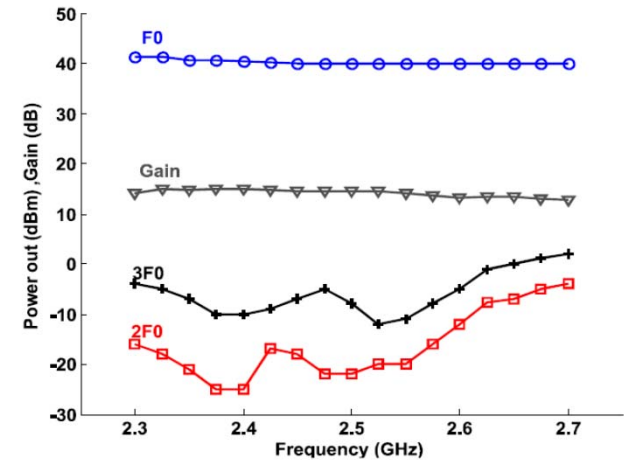
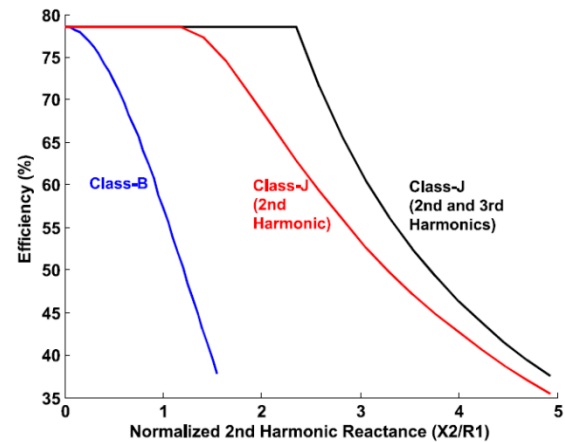

- New class of power amplifier. Eliminates harmonics at loading stage
- Maintains good amplification and efficiency over a wide range
- Can have 60% efficiency over 100s of MHz (30% for Class AB)
- Needs some power backoff
- Very attractive but so far limited to Gallium Nitride (GaN) semiconductor technology

F0 is fundamental, 2F0 and 3F0 are harmonics



Energy-Efficient Transmission Modes

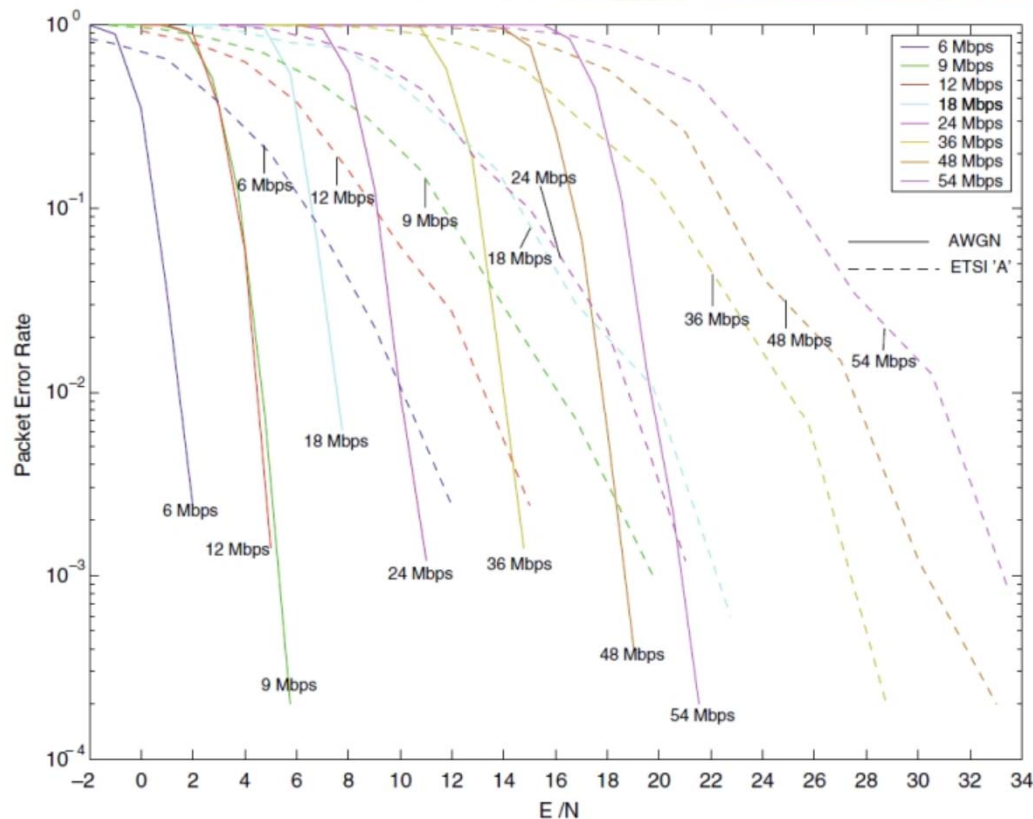

- IEEE 802.11a PER vs. E_s/N_0 performance in AWGN and fading channel
- For higher rates with acceptable loss, SNR should be larger than a threshold
- Conventionally, *link adaptation algorithms* try to give the user the highest rate
- However, highest rate is not necessarily the most energy-efficient (has higher energy and the time it takes to transmit a packet needs to be considered)



Conventional Link Adaptation



- A number of link adaptation algorithms have been proposed for wireless networks
- The goodput values for various IEEE 802.11a modes in AWGN are shown in the top figure
- The middle figure depicts the best overall effective goodput
- The bottom figure shows the outcome of a link adaptation algorithm with the best effective goodput criterion
- Note Mode 2 is not part of the algorithm since Mode 2 always results in smaller goodput than Mode 3

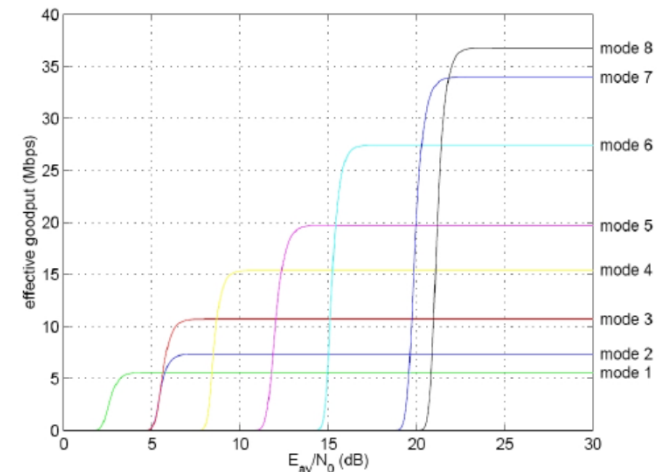

Fig. 11. Effective goodput vs. SNR [68].

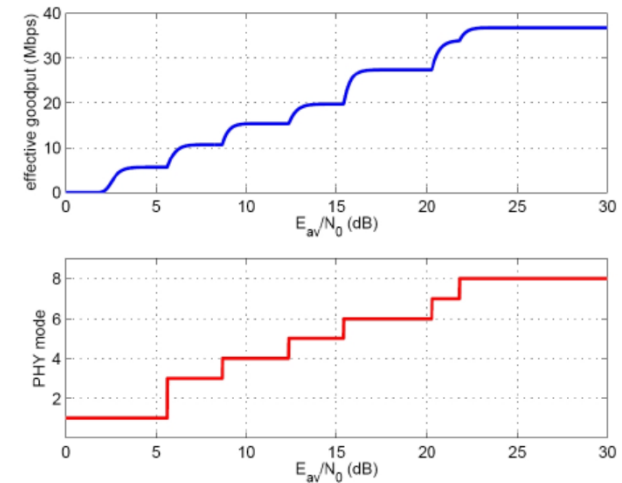

Fig. 12. Best effective goodput and the link adaptation algorithm [68].



Energy-Efficient Link Rate Adaptation



- Best rate for throughput is not necessarily the most energy-efficient rate (energy = power x time)
- A formulation for most energy-efficient link adaptation is not straightforward
- An example uses the optimization

$$\begin{aligned} & \max_{E_T, BW} \frac{(1 - \text{PER}) \cdot L}{E_T \cdot \text{BW}} \text{ (bits/J/Hz)} \\ & \text{subject to } (1 - \text{PER}) = (1 - \text{BER})^L, \\ & \frac{(1 - \text{PER}) \cdot L}{T} \geq R_0, \end{aligned}$$

where E_T is the energy to transmit L bits during T seconds using a bandwidth of BW and bit error rate BER , while R_0 is the minimum acceptable rate

- Models are needed to relate energy consumption, throughput, and BER to the parameters given



Energy-Efficient Link Rate Adaptation Implementation



- The optimization problem can be translated into a Geometric Programming (GP) which can be solved efficiently using convex optimization theory
- The problem formulation can be cast as the optimization of one of two objectives
- The first is the minimization of the total energy used per successfully received bit
- The second is the maximization of throughput
- Simulations show very large gains, close to an order of magnitude
- However, this gain is in terms of transmitted and received energy, it excludes the bulk of the static energy consumed by the system
- Nevertheless, it shows the importance of judiciously choosing transmit parameters for energy, and not power, efficiency



Energy-Efficient Link Rate Adaptation Simulation Results

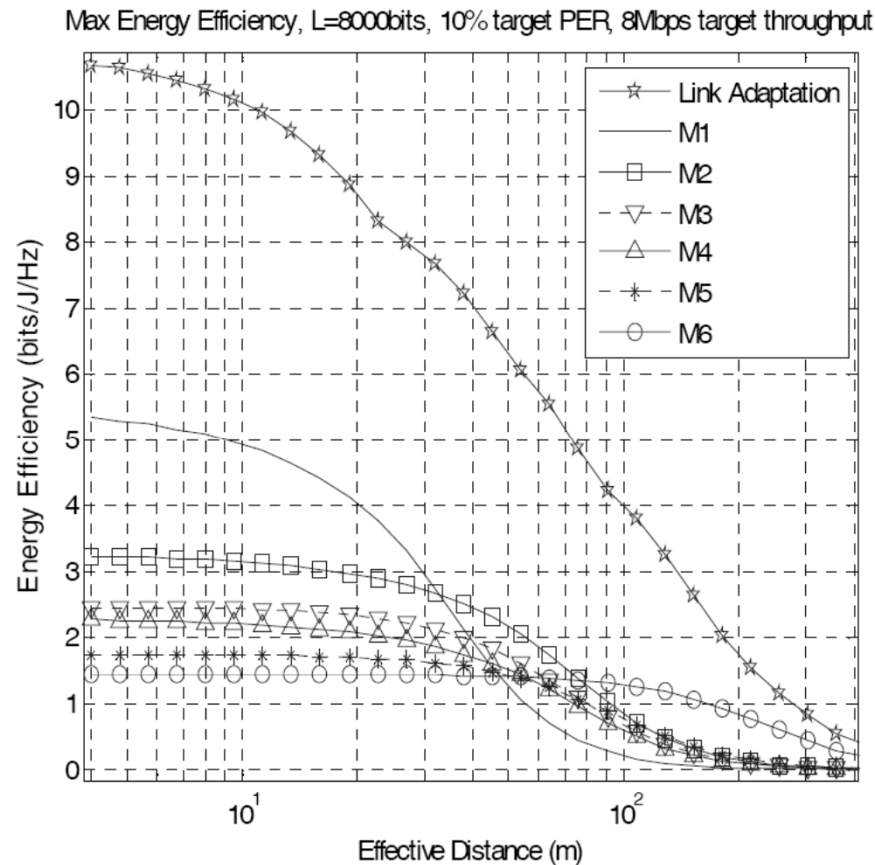

- M1-M6 are different static modes with different coding, modulation, and MIMO parameters



Cellular Network Design

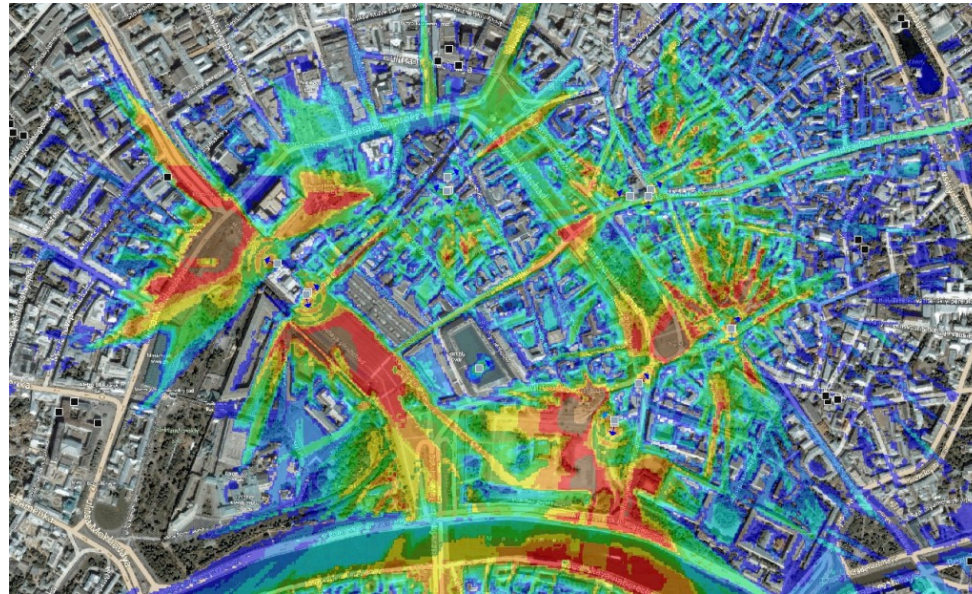

- For cellular networks, design and planning requires an understanding of propagation conditions and path loss
- The goal is to increase capacity and throughput
- This is the most challenging part the overall design of the cellular network
- Tools exist but expertise is still required

Example: Automated Frequency Planning in Wi-Fi

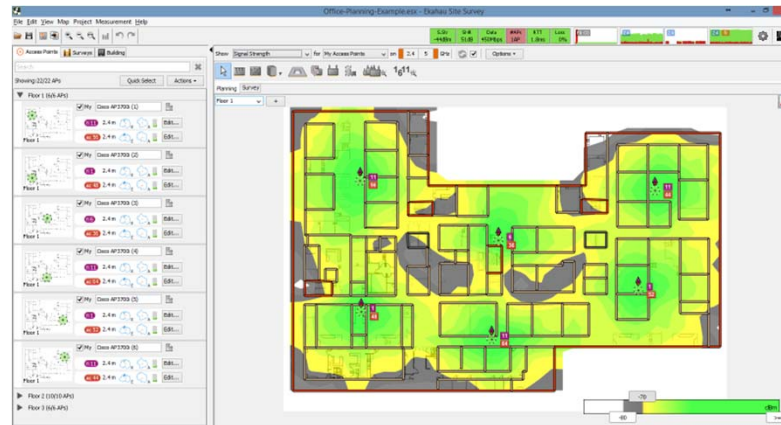

- The same planning problem exists in Wi-Fi
- To help system administrators (normally no expertise in propagation conditions), various manufacturers have incorporated automated design tools
- System administrators do a “site survey,” a walk-through at the site
- The tool determines the best locations for APs, frequency selection, transmit power, cell coverage
- A desirable feature of dynamic planning against failures, turning off select APs during off-peak hours is usually incorporated
- Similar automated frequency planning tools for cellular networks exist, but none is based on optimizing energy efficiency. Such tools are highly desirable and needed



Exploiting Distribution of Traffic in Space



- Figure shows the distribution of traffic in a 10 km x 10 km area in the city of Wellington, New Zealand
- There are parts of the city, e.g., (4, 2) and (4, 4) where the user traffic has a ratio of 20/1 or more with respect the rest of the city
- This distribution varies with time
- The combined potential of exploiting the variation in traffic over space and time is tremendous
- This can be cast as a problem in controlling a plant with respect to time-varying input

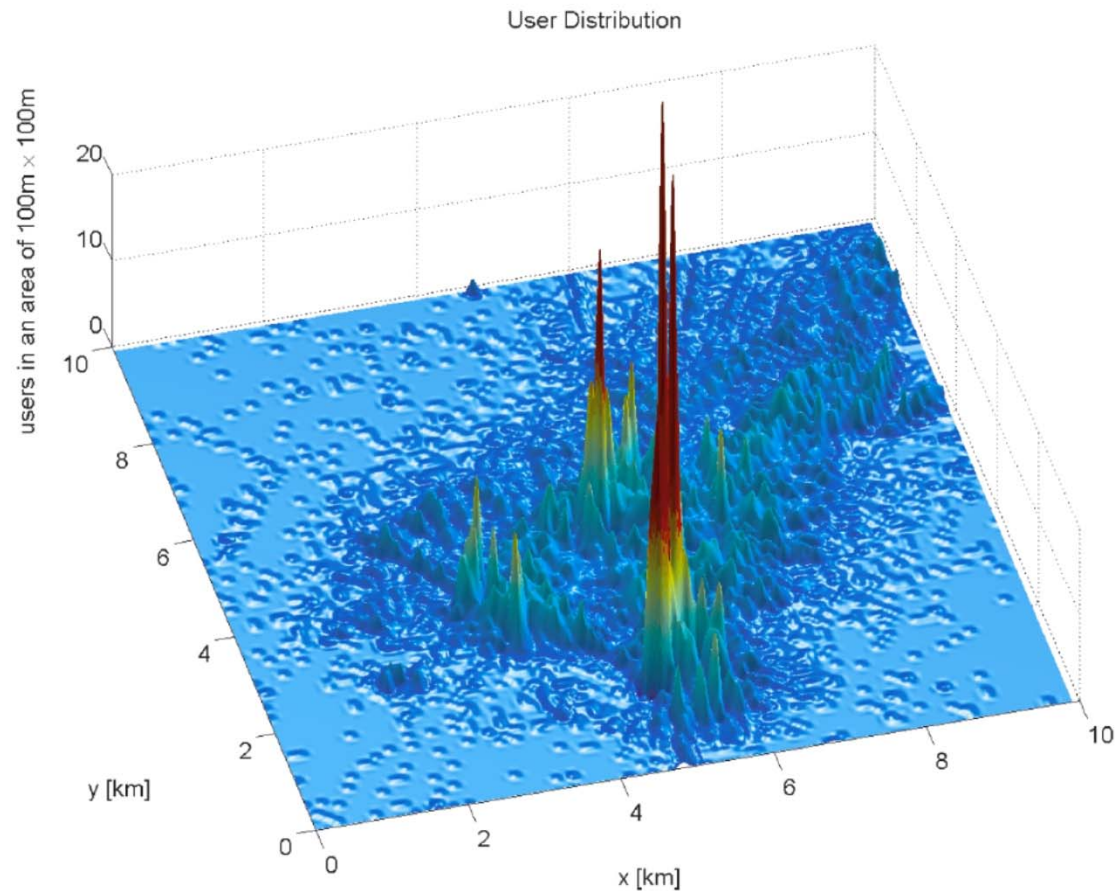

A Load Balancing Problem Formulation



- A joint cell selection and power allocation problem
 - The load of the most heavily node should be minimized (Objective function)
 - Every user should be provided with sufficient QoS (SINR, Constraint)
- The Linear Program (LP) to be solved is

$$P : \min_{p_{mc}} \max_c L_c$$

subject to

$$\sum_{c=1,C} \alpha_{mc} p_{mc} \geq \gamma \left(\eta + \sum_{c=1,C} \alpha_{mc} L_c \right) \quad \forall 1 \leq m \leq M$$

$$L_c = L_{OH} + \sum_{m=1,M} p_{mc} \quad \forall 1 \leq c \leq C$$

with $p_{mc} \geq 0$ and $L_c \geq 0$.

where α_{mc} is the propagation loss, γ is the target SINR, η is the thermal noise floor, L_c is the load in cell c , and L_{OH} is the load of the overhead cells



Problem Solution



Table I. Comparative studies via simulations of the linear programming solutions and the distributed dual-ascent implementations compared to standard 3G systems.

Scenario	Data rate (arb. units)	Load reduction in worst cell: LP compared to 3G1X					
		Exact LP solution			Distributed implementation		
		min	mean	max	min	mean	max
A	10	16%	60%	99%	13%	60%	99%
B	10	6%	46%	99%	3%	45%	99%
C	10	7%	52%	96%	5%	52%	95%
D	10	3%	22%	48%	2%	21%	48%
A	20	14%	63%	98%	8%	62%	98%
B	20	5%	48%	98%	2%	47%	98%
C	20	1%	52%	97%	0%	51%	97%
D	20	1%	31%	93%	0%	29%	93%
A	40	21%	62%	98%	13%	61%	98%
B	40	5%	49%	97%	0%	48%	97%
C	40	3%	52%	97%	0%	51%	97%
D	40	1%	34%	96%	0%	32%	96%

3G1X—CDMA2000+ first evolution
LP—Linear program

- The problem can be solved via standard LP solvers or by a distributed algorithm



Example: Exploiting the Nonuniform Traffic in Space



- Paper by P. Gonzalez-Brevis *et al.*, in *Proc. VTC-Spring*, May 2011 provides an example of exploiting the nonuniform distribution of traffic in space
- Considers an urban or rural cellular network in which the problem is to place several small base stations to reduce the overall use of energy
- Formulated as finding the optimal number and position of base stations so that the long-term total energy consumption is minimized
- This problem is cast as a *facility location problem* in operations research
- The goal is to minimize the cost of installation (fixed cost) and unitary cost of transporting products from these facilities to each customer (variable cost)
- The paper proposes a Mixed Integer Programming solution to the problem
- Simulation results show that 96% or more power reduction can be achieved for the example scenario considered in the paper



Relays and Cooperation

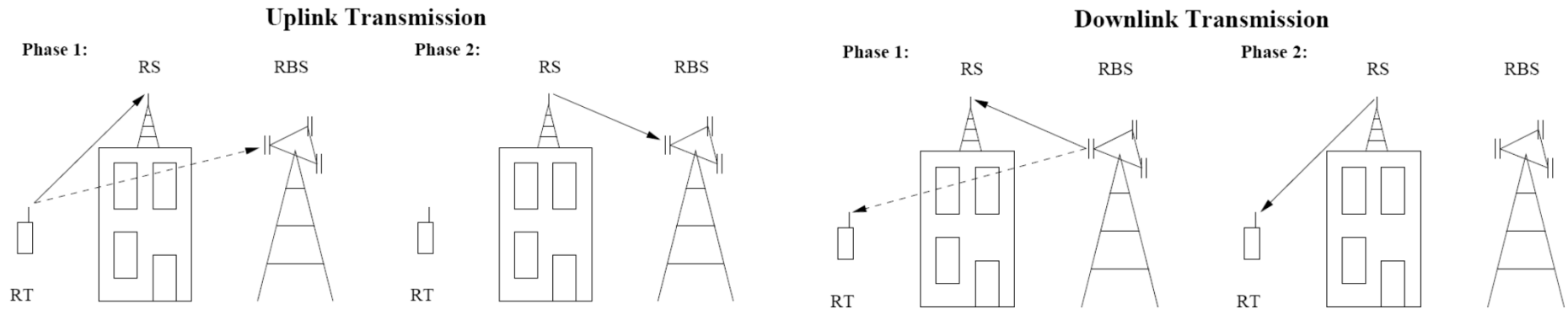

- Cooperation in communication networks leads to performance improvement
- A relay generates a means for cooperation
- Although not common in cellular networks today, relays may be deployed in the future
- Relays can be dedicated network elements, placed at planned or unplanned locations in a cell to help forward the message in the uplink or the downlink
- They can be placed on rooftops, lamp posts, or building walls
- Service providers want to deploy them as cost-effective ways of providing cell coverage and capacity enhancement but recent studies show they can help in energy efficiency



Relays for Energy Efficiency



- Use of relays for improving energy efficiency may be counterintuitive since relays add energy consumption to the network
- However, several studies show that there are gains
- The locations of relays and how to operate them for maximum energy efficiency are still research questions
- Three different relay selection techniques have been devised
 - Single relay selection, choosing the one with the largest channel gain
 - Choosing the best M relays
 - Optimal selection where the number and the relay set choices can vary with time
- With optimal relay selection, 16% gain has been reported



A Study on Relays for Energy Efficiency



- Several works have established that an energy efficiency gain by the use of relays can exist
- Estimating the amount of the gain depends on a number of assumptions
- One publication that addresses where to place the relays and how to operate them for maximum energy efficiency is by W. Yang *et al.*, published in *The Journal of China Universities of Posts and Telecommunications*, December 2010
- Optimum relay location and optimum relay selection algorithms have been developed for energy-efficient cooperative network
- The work is for asymmetric traffic
- Succeeds in developing a joint uplink and downlink relay selection algorithm
- A successful start in an area that needs more work, especially regarding study of realistic channel and network conditions



Device-to-Device (D2D) Communications

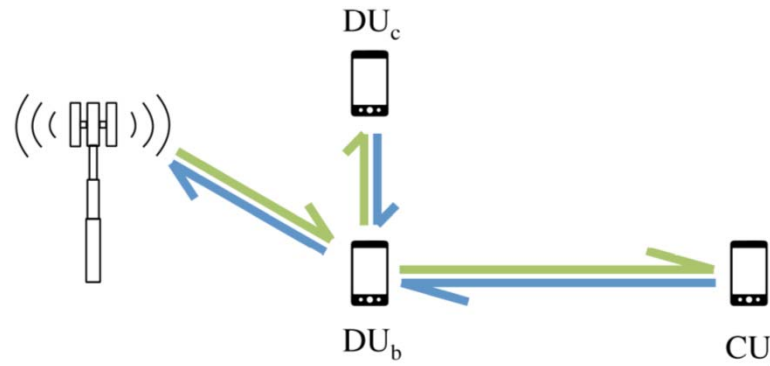

- D2D is new relaying approach where RTs function as relays
- Studies have shown that D2D can increase system throughput, provide larger coverage, or improve energy efficiency
- Examples of improvement from the literature
 - System throughput improvement of 65%
 - Median cell capacity improvement of 2.3x
 - For short distances, 10x energy efficiency improvement!



D2D Challenges



- When to use the D2D link or the cellular link needs to be specified. This is known as the mode selection problem
- Energy-efficient measurement and reporting mechanisms to be employed during mode selection are needed
- These mechanisms should be robust and scalable for dense networks
- Time scale and speed of updating these mechanisms need to be quantified

and

- As in all cooperative mechanisms, will the users be willing to relay traffic that belong to others?



Multiple Antenna Techniques

- Employing directional antennas in cellular networks has been under investigation since 1990s
- The area used to be known as “smart antennas” but it is now known as MIMO
- MIMO improves system performance by
 - Increasing the diversity order of the system, improving BER vs. SNR performance
 - Establishing spatial multiplexing, generating independent data streams over the air, thereby increasing throughput

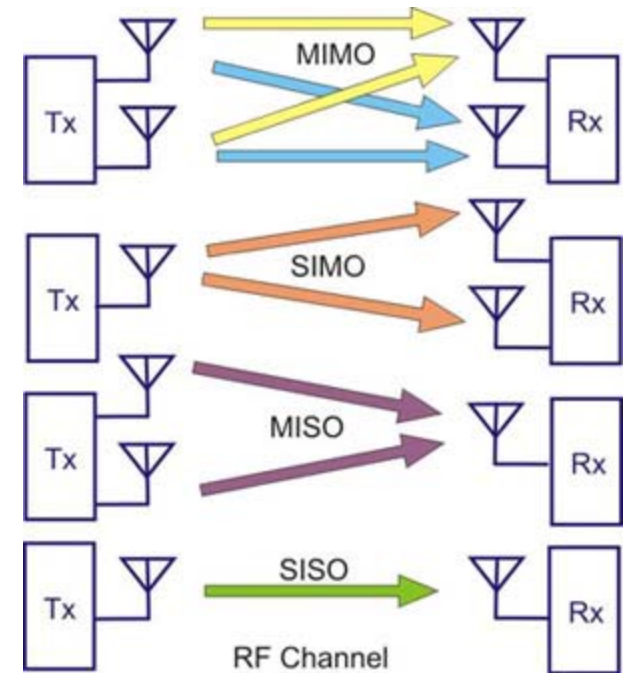
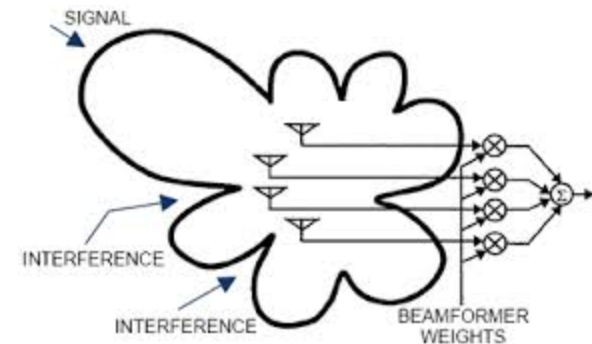

Beamforming

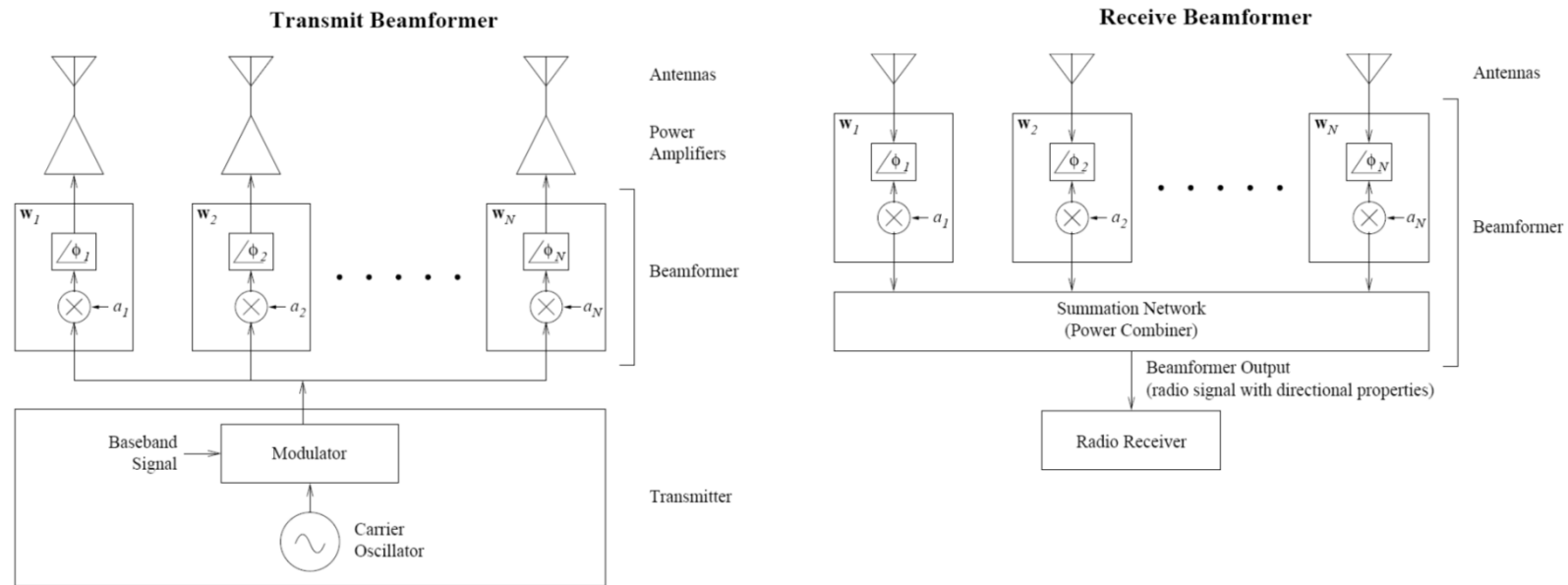

- Beamforming or beamsteering techniques can be employed to provide gain in SNR, without diversity or spatial multiplexing advantage, or they can be employed in a MIMO system with additional gains
- This additional gain can be used for increased power or energy efficiency
- Due to antenna reciprocity, beamforming can provide gain during transmission or reception



Multiple Antennas at RBS and RT

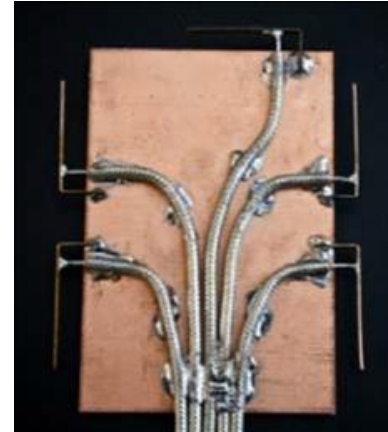

- Employing multiple antennas at RBS (space less of a factor) is studied widely in the literature, not as much at RT (space big factor)
- It has been shown that employing multiple antennas (4 antennas) at RT improves power efficiency by 55%
- It is possible to place 4-5 antennas on RTs at frequencies of interest
- A power efficiency figure of 55% is very significant, but there are challenges to be overcome before it becomes reality

How Many Antennas Should be Placed at RBS and RT?



- Power efficiency increases with the number of antenna elements
- Minimum antenna distance is a fraction of a wavelength (usually $\frac{1}{2}$)
- For future applications, multiple radios will likely be needed in RTs
- About five antennas per radio is expected to be placed on RT
- AT RBS, a large number of antennas can be employed. A new technology suggests 10s or even 100s of antennas may be placed at an RBS. This is known as Massive MIMO and will be discussed in the sequel



Coordinated Multipoint (CoMP)

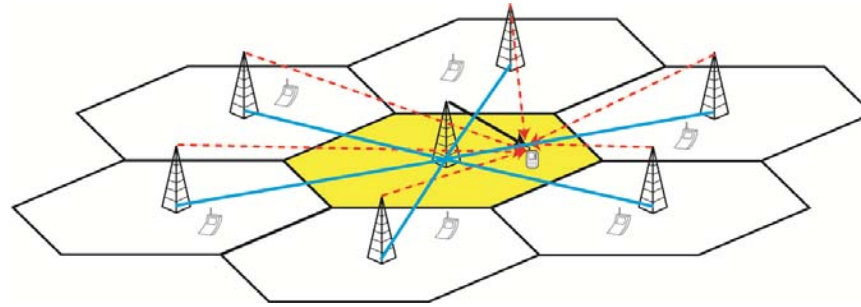

- MIMO techniques are currently part of the LTE standard
- The improvement in spectral efficiency, however, has been modest
- MIMO employs frequency reuse within each cell but are still subject to interference from other cells
- Intercell interference is a superposition of signals intended for other RBSs
- If the different RBSs were cooperating, they can resolve the interfering signals as long as sufficient degrees of freedom exist
- In this approach, frequency reuse is not needed. This contributes to spectral efficiency in a major way
- The uplink channel is a multiaccess channel and the downlink channel is a broadcast channel (not interference channels)

CoMP Versions of Implementation

- CoMP was introduced under the name Network MIMO. It was adopted by LTE community very fast and is now part of LTE-Advanced standard
- CoMP has two versions of implementation
 - In **Coordinated Scheduling and Beamforming**, one RBS is employed for transmission or reception, but to multiple RTs. The RBSs employed for transmission or coordinated via scheduling or beamforming so that the effect of their interference is minimized. This version does not require substantial data transfer
 - **Joint Processing** employs multiple RBSs for simultaneous transmission or reception of data. It places a high demand on the backhaul network
- Since CoMP (especially Joint Processing) employs multiple RBSs, what is the energy efficiency. Does it degrade substantially?

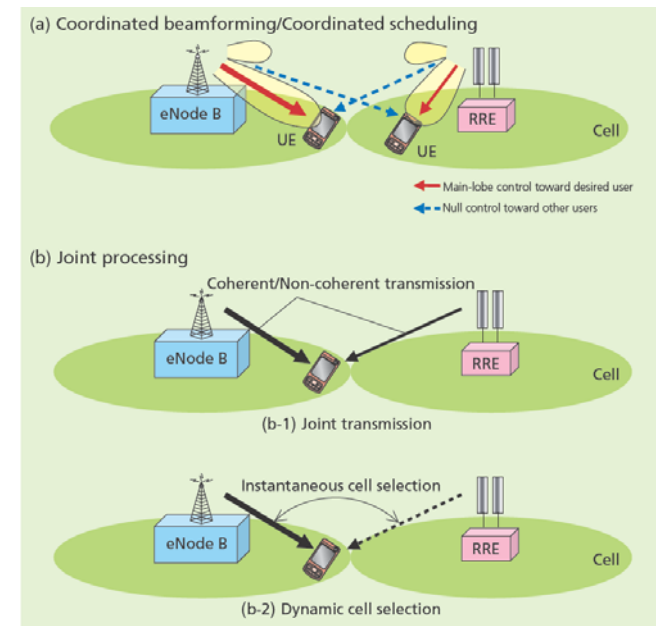

Energy Efficiency of CoMP

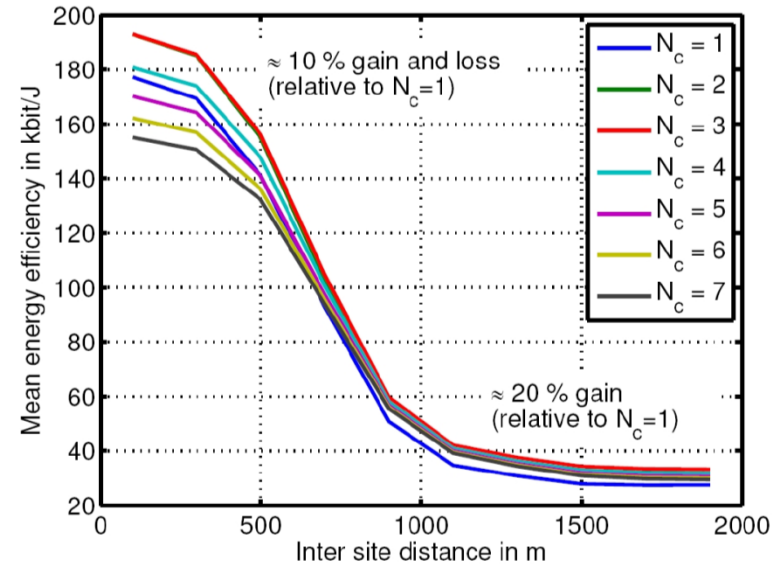
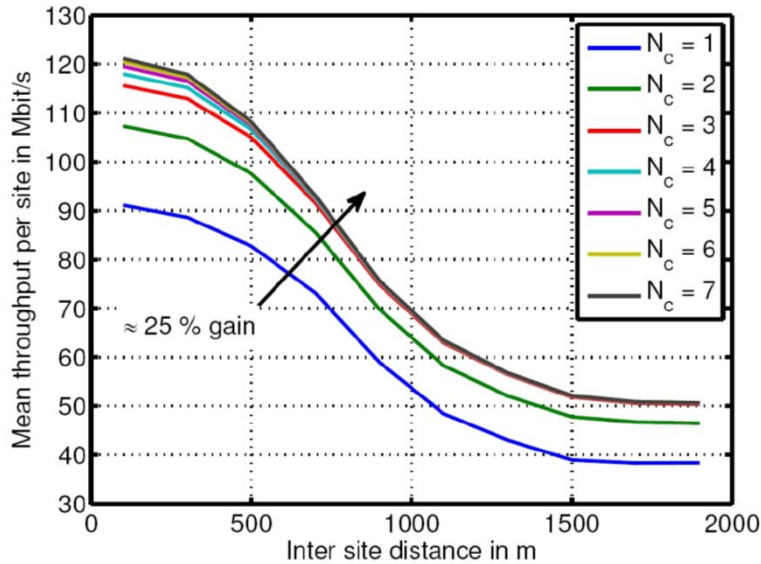

- CoMP was analyzed with joint processing
- A hexagonal structure was assumed and standard models for the channel, propagation, backhauling, and energy consumption are assumed
- The results are presented in terms of inter distances of RBSs and parameterized in terms of N_c (number of cooperating cells)
- Surprisingly, CoMP may lead to decreased energy



Massive MIMO



(a)



(b)

- New version of MIMO with 10s or 100s of antennas at RBS
- Asymptotic arguments can be used to show that as the number of antennas grow, the effects of uncorrelated noise and fast fading vanish
- Simple linear processing such as Maximum Ratio Combining or Maximal Ratio Transmission are sufficient to achieve very high throughput to a multiple set of users with a very high spectral efficiency
- Example: 17 Mb/s for 40 users in 20 MHz, both uplink and downlink with a per-cell throughput of 730 Mb/s at a spectral efficiency of 26.5 bps/Hz

Energy Efficiency in Massive MIMO

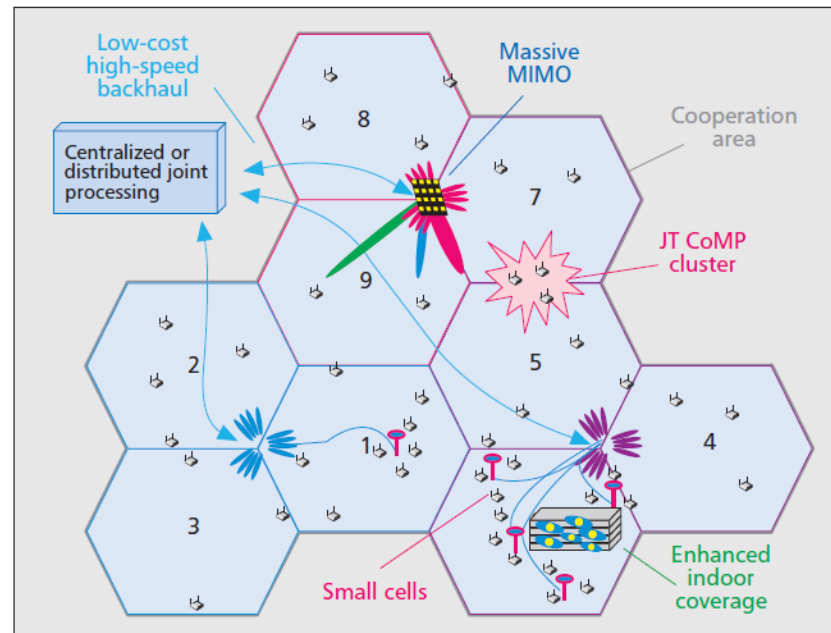

- It has been shown that each RT in the uplink of a massive MIMO system requires only $1/N_t$ of the overall power to transmit
- A similar result holds for the downlink
- Then, in massive MIMO, each individual PA needs to generate only $1/N_t$ of the output power
- Considering the large number of antennas, the resulting gains can be significant
- However, each PA should still achieve energy-efficient transmission

Sleeping Mode for RBSs

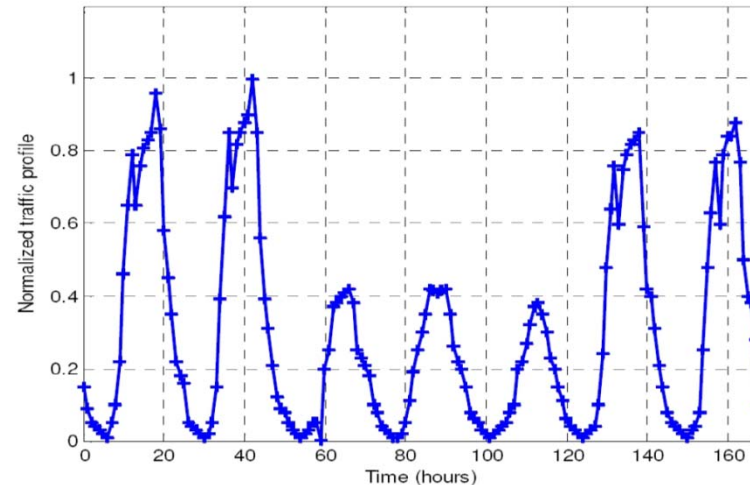

- Considering how much variation in cellular traffic exists over time and how much power is used for transmitter idling, adding a sleep mode to RBSs is often suggested
- This can be accomplished by
 - Shutting down RBSs completely
 - Shutting down by a number of channels
 - Shutting down a number of services (e.g., high data rate services)
- Several studies quote 15-30% energy savings by using a sleep mode

An Integer Programming Formulation



$$\min_{x_i^{fh}} \sum_{h=1}^H W_h \sum_{i=1}^N \sum_{f=1}^{F_i} P_f^i x_i^{fh}$$

such that $\sum_{f=1}^{F_i} C_i^f x_i^{fh} \geq d_i^h, x_i^{fh} \in \{0, 1\}$ for all h, i, f .

- A day is divided into non-overlapping periods $\{1, 2, \dots, H\}$
- W_h is the percentage of the period h in $\{1, 2, \dots, H\}$
- d_i^h is the traffic demand in cell i during the interval h
- C_i^f is the capacity of frequency f at cell i
- P_i^f is the power consumption of frequency f at cell i
- x_i^{fh} is a binary control variable, $x_i^{fh} = 1$ if frequency f is active in cell i during h , $x_i^{fh} = 0$ otherwise
- N is the total number of cells, F_i is the frequencies assigned to cell i



Energy Efficiency Savings due to Sleeping Mode



Cell Type	Savings
1	48%
2	45%
3	52%
4	65%

- Service area is divided into
 - 1) Business
 - 2) Residential
 - 3) Entertainment
 - 4) Highway
- The reference studies shutting down some services without much change in the results. This, and the fact that shutting down services would not be desirable by the customers, means shutting down services is not viable
- Note that the gains are substantial



Another Study

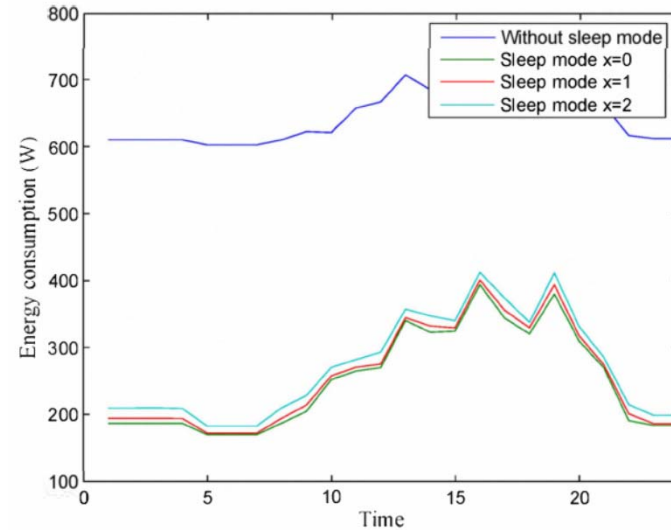
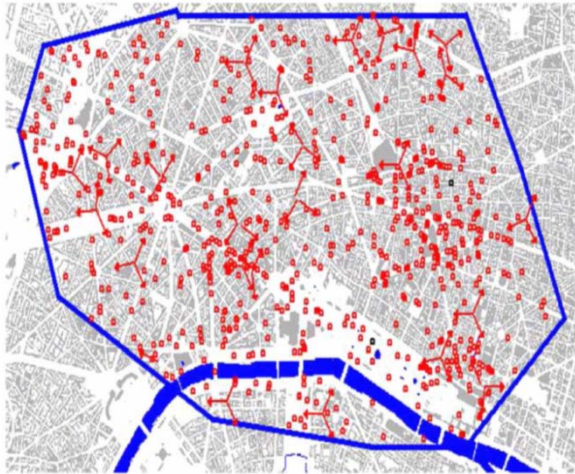

- Conducted in part of Paris, France
- Studies the problem under more realistic conditions
- It considers turning off a number of carrier frequencies
- Points to the consequences of blocking call generation or handoff of some cells
- Finds substantial gains

Sleeping Mode for RBSs: Conclusion



- Completely shutting down an entire cell may not be feasible due to satisfying user QoS, coverage, and regulatory requirements
- Reduction of a number of carrier frequencies can lead to substantial energy savings for network operators
- It will be necessary to accommodate nonzero turning on and turning off times. Both RBSs and RTs will need this capability
- Shutdown of frequencies should be coordinated among cells so that different frequencies are turned off in neighboring cells to minimize interference
- The potential to remove sectoring and employing omnidirectional antenna patterns to reduce power consumption at PAs should be studied
- The use of small cells and hierarchical cells should be investigated
- Shutdown feature will be important for small cells such as femtocells



Reduced Cell Size and Hierarchical Cells



- Today's cellular network has its origins in a desire to provide voice service to mobile users
- An important aspect of the technology is the seamless handover of a user from one RBS to another as it moves through different cells
- The technology and the applications are changing
- There is no need to keep the same architecture
- We can enhance the architecture



Wireless Data Service Users Do Not Have High Mobility



- In 2008, 54% of cellular traffic was generated indoors
- In 2015, it is expected that this number will increase to 74%
- Everyday experience would lead to the estimate that only a minority of the traffic generated outdoors originates from high mobility devices, most being generated by pedestrians or by users with no mobility
- Users with high mobility can be served by cells of conventional large sizes
- Users who do not have high mobility can be served by an underlay cellular network



Hierarchical Cellular Network

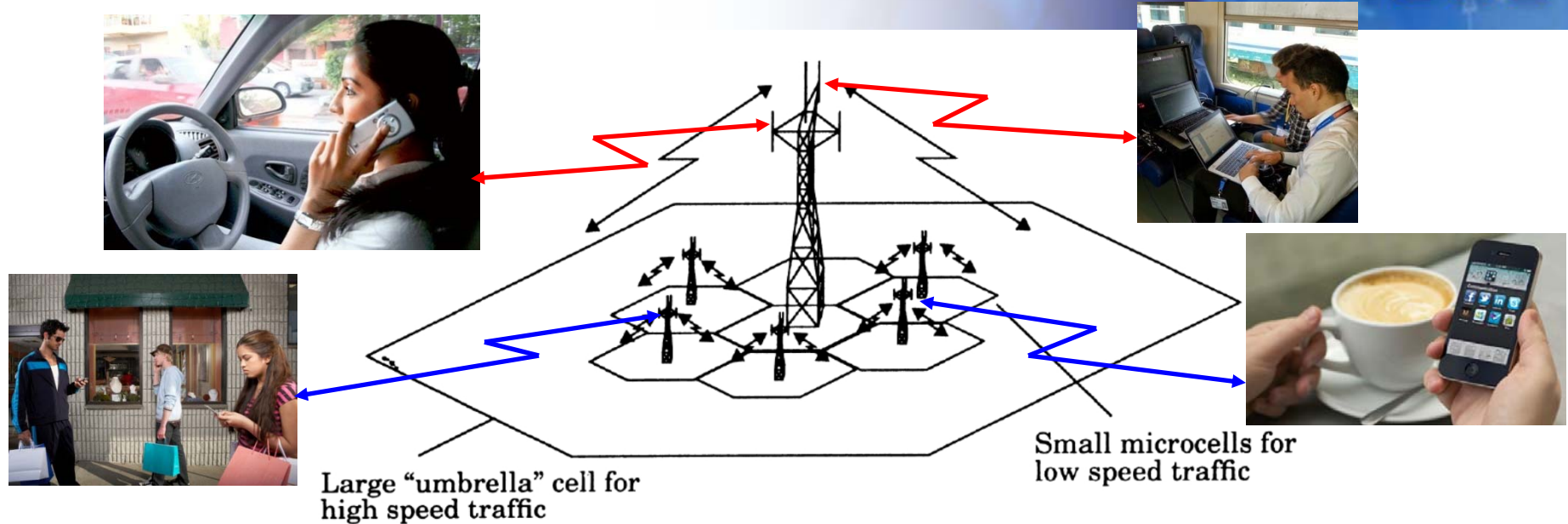

- Small cells are under consideration to increase cellular wireless network throughput
- A macrocell has a radius of a few kms. According to LTE-Advanced, a macrocell has a radius of 500 m for urban macrocells and 1.7 km for rural macrocells
- With today's technology, it is not difficult for the wireless network to determine a user's location or velocity
- When a user's velocity is determined, it is possible to locate the user in the high-speed or low-speed part of the network

Example Cellular Network with Backhaul: Ricochet



- A network using APs placed on lamp posts, providing Internet service, is realistic
- Ricochet was designed and put in place by Metricom Inc. in 1994 and was operational until 2006
- Provided Internet access in 16 major metropolitan areas, serving about 51K customers in 2001
- Its APs also functioned as repeaters, providing backhaul capabilities
- We are now at a point in new technological capabilities could provide broadband service



How to Formulate?

- One problem formulation assumes one has a deployment of macrocells \mathcal{M} and wants to build an overlay network of \mathcal{P}
- The goal is to satisfy an Area Spectral Efficiency value of $ASE_{\mathcal{MUP}}(\mathbf{r})$ (bits/s/Hz/m²) after the introduction of picocells
- For a given location \mathbf{r} and a given deployment of cells, the Signal-to-Interference-plus-Noise Ratio $SINR_{\mathcal{MUP}}(\mathbf{r})$ can be calculated. This leads to the bandwidth efficiency figure

$$\eta_{\mathcal{MUP}}(\mathbf{r}) = \log_2(1 + SINR_{\mathcal{MUP}}(\mathbf{r})) \text{ (bits/s/Hz)}$$

and to $ASE(A)$ for an area A

$$ASE_{\mathcal{MUP}}(A) = \frac{\int_A \eta_{\mathcal{MUP}}(\mathbf{r})p(\mathbf{r})d\mathbf{r}}{\int_A d\mathbf{r}} \text{ (bits/s/Hz/m}^2\text{)}$$

where $p(\mathbf{r})$ is the probability density function for location \mathbf{r}

Difficult Problem But Solutions Exist



- Then, the optimization problem to solve is

$$\min_{\mathcal{P}} \mathbb{E}[\mathcal{M} \cup \mathcal{P}] \quad \text{subject to } \text{ASE}_{\mathcal{M} \cup \mathcal{P}}(A) \geq S_0$$

where $\mathbb{E}[\mathcal{M} \cup \mathcal{P}]$ represents the energy consumption of the configuration $\mathcal{M} \cup \mathcal{P}$ and S_0 is the minimum acceptable ASE figure for the area

- Although analytical expressions for $\mathbb{E}[\mathcal{M} \cup \mathcal{P}]$ and $\text{ASE}_{\mathcal{M} \cup \mathcal{P}}(A)$ may be available, this is in general a difficult problem
- But the limited number of locations for \mathcal{P} enables the use of a greedy algorithm or a combinatorial optimization technique
- This approach can be used for deployment as well as operation of a hierarchical cellular network
- The general approach can be used for optimization of measures other than ASE



Energy Efficiency of Mobile Units



- It is known that 80% of the total power in cellular networks is consumed at RBSs.
- But, Moore's law states processor capabilities double every two years, meaning more traffic TX and RX at RTs
- Processor speeds increased by about two orders of magnitude in the last 10 years, but the battery capacity has only increased 80%
- Same period, output power level of a typical RT has doubled, with another factor of two expected in ten years
- As a result, there is a power bottleneck for mobile RTs
- Users will have to constantly search for power outlets. This problem is called the "energy trap"



A Solution to the Energy Trap Problem: DRX in LTE

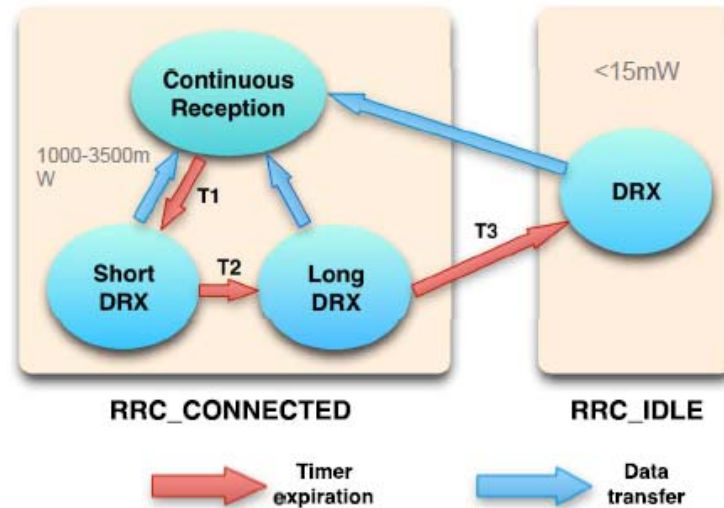

- Solution of the Energy Trap problem via conventional means is difficult
- DRX (Discontinuous Reception) is a feature of the LTE standard that introduces micro sleep cycles
- During DRX modes, an RT shuts down most of its circuitry and does not transmit or receive any packets
- DRX parameters can be optimized to introduce energy savings
- Simulations show that 40-45% energy savings are possible for video and 60% for VoIP applications



How Much Gain Is There?

- Given smaller cells, and with a distributed algorithm to dynamically change used power based on traffic, substantial savings in energy use can be achieved
- Depending on traffic, different channel allocations can be employed and some APs can be turned off
- Reference [1] states about 60% energy reduction is possible in urban areas for high rate demand using today's technology
- Reference [2] calculates, only by using a power off feature, depending on the type of deployment, 50-80% savings
- Reference [3] estimates that, by using some intelligence and coordination among RBSs, 80% savings during a weekday and 95% during a weekend are possible

[1] H. Claussen *et al.*, *Proc. PIMRC '08*

[2] M. Jada *et al.*, *Proc. IC-BNMT, '10*

[3] K. Son *et al.*, USC CENG-2010-10, '10



Video and Energy Efficiency



- Video traffic is expected to be dominant in future cellular networks
- The question is, can it be handled in an energy-efficient way?
- The conventional way video energy efficiency is handled is for the RT and use of techniques from
 - Source coding
 - Channel resource allocation
 - Energy allocation
- One example reduces energy consumption by 50% compared to conventional H.264/AVC (Advanced Video Coding)
- Since most of the energy consumption is in RBSs, methods applicable to RBSs are needed
- We will discuss three methods



First Method for Video and Energy Efficiency



- It is called Client-Buffer-Related-Energy-Efficient Video Transmission (CBEVT)
- It provides the largest energy savings among the three
- Models power consumption in various analog blocks both at TX and RX
- Calculates the dissipated energy in terms of transmission parameters such as modulation characteristics
- Reported to achieve energy savings up to 85%



Second Method for Video and Energy Efficiency



- Employs user mobility to increase energy efficiency for video
- Transmissions are most efficient when the RT is close to the RBS
- Techniques monitor the buffer occupancy and the actual playback time of the video in order to make most of the transmission when the RT is close to the cell center



Third Method for Video and Energy Efficiency



- A system model based on Finite-State Markov Chain is used to evaluate average service data rates
- New bandwidth and energy performance measures are introduced
- Employs video services standardized in LTE, known as evolved Multimedia Multicast/Broadcast Service (eMBMS)
- Significant gains are shown to be possible, but they are not uniform
- Cell-edge locations with two times transmission rate improvement and there are cell locations with 80% energy gain



Surveys on Green Cellular Networks

Green Radio: Radio Techniques to Enable Energy-Efficient Wireless Networks

IEEE Communications Magazine • May 2011

Congzheng Han, Tim Harrold, and Simon Armour, University of Bristol

Ioannis Krikidis, Stefan Videv, Peter M. Grant, Harald Haas, and John S. Thompson, University of Edinburgh

Ivan Ku and Cheng-Xiang Wang, Heriot-Watt University

Tuan Anh Le and M. Reza Nakhai, Kings College London

Jiayi Zhang and Lajos Hanzo, University of Southampton

- The authors are affiliated with universities in UK, participating in the Mobile Virtual Centre of Excellence Green Radio project, established in 2009
- A 50% reduction in the power required to operate an RBS is targeted
- Two measures (metrics) of energy efficiency are defined
- One is Joules per bit, an absolute measure
- A relative measure compares the energy consumption by a particular implementation against a standard one while some parameter such as throughput is kept equal



Three Case Studies



- Tradeoff in bandwidth: In order to achieve a given throughput, one can choose a lower size constellation but employ a larger bandwidth, rather than keeping the size of the constellation thereby increasing power consumption
- Different interference cancellation techniques have different values of energy consumption gain
- Use of relays can aid in the energy efficiency of an RBS



Green Cellular Networks: A Survey, Some Research Issues and Challenges

Ziaul Hasan, *Student Member, IEEE*, Hamidreza Boostanimehr, *Student Member, IEEE*, and
Vijay K. Bhargava, *Fellow, IEEE*

- A survey of energy-efficient cellular networks with an emphasis on cognitive radio and cooperative relaying
- A discussion on how to measure energy efficiency
- Three energy efficiency metrics: Facility-level, equipment-level, network-level
- The paper goes into further detail in metrics: Two in the first category, six in the second category, and two in the third category. The list is specified as non-exhaustive
- No conclusive statements as to which is preferred



Z. Hasan *et al.*, Continued



- Discusses RBS architectures for energy efficiency
- First, it specifies the sleeping modes for WiMAX and LTE
- Then, it specifies the sleeping modes, Discontinuous Transmission (DTX) and Discontinuous Reception (DRX) in LTE
- Discusses cooperative RBS power management studies
- Discusses a hierarchical network structure, but does not discuss the concept on the basis of mobility



G. Li *et al.*



ENERGY-EFFICIENT WIRELESS COMMUNICATIONS: TUTORIAL, SURVEY, AND OPEN ISSUES

GEOFFREY YE LI, ZHIKUN XU, CONG XIONG, CHENYANG YANG, SHUNQING ZHANG,
YAN CHEN, AND SHUGONG XU

IEEE Wireless Communications • December 2011

- Concentrates on relays for energy efficiency
- Points out to the importance of additional overhead for relays considering both the additional time and energy used
- Brings up the point that most existing work focuses on point-to-point transmission
- States point-to-multipoint and multipoint-to-point are important problems worthy of investigation
- Points out to the importance of bidirectional relays
- Poses a research question of how to design an energy-efficient bidirectional relaying system



A Survey of Green Networking Research

Aruna Prem Bianzino, Claude Chaudet, Dario Rossi, and Jean-Louis Rougier

- A classification of green networking research
- More general than green cellular or green wireless networks but applicable to green wireless communications
- Specifies four general areas green networking efforts may fall under, a classification it calls a *taxonomy*
- Articulates each of the four parts
- Identifies, for 22 publications in networking, which of these areas they belong to. A particular publication may belong to more than one class



Four classes in Bianzino *et al.*



- First class is adaptive link rate. Makes a distinction between reaching the value zero or a sleeping mode and a changing set of rates
- Second class is called interface proxying. Can be thought of employing a number of peripheral units so that the power-hungry central processor is avoided
- The remaining two classes cover potential implementations that do not fall under the first or the second classes above
- Third class involves hardware implementations or infrastructure
- Fourth class involves software implementations or applications
- If adopted by the research community, this taxonomy will provide a standard way of classifying different attempts towards green networks
- It applies to wireline or wireless networks



A Survey of Energy-Efficient Wireless Communications

Daquan Feng, Chenzi Jiang, Gubong Lim, Leonard J. Cimini, Jr., *Fellow, IEEE*,
Gang Feng, *Senior Member, IEEE*, and Geoffrey Ye Li, *Fellow, IEEE*

- Discusses a number of international research projects for energy-efficient wireless communications, i.e., Green radio, EARTH, OPERA-Net, and eWIN
- These research projects are analyzed in a table in terms of their energy metrics and models, hardware, architecture, and resource management
- Provides a discussion of measures for energy efficiency
- Criticizes the conventional approach of considering only the transmit power consumption and suggests other sources such as circuit power consumption
- Emphasizes the importance of QoS considerations
- Discusses future work in all sections



Books

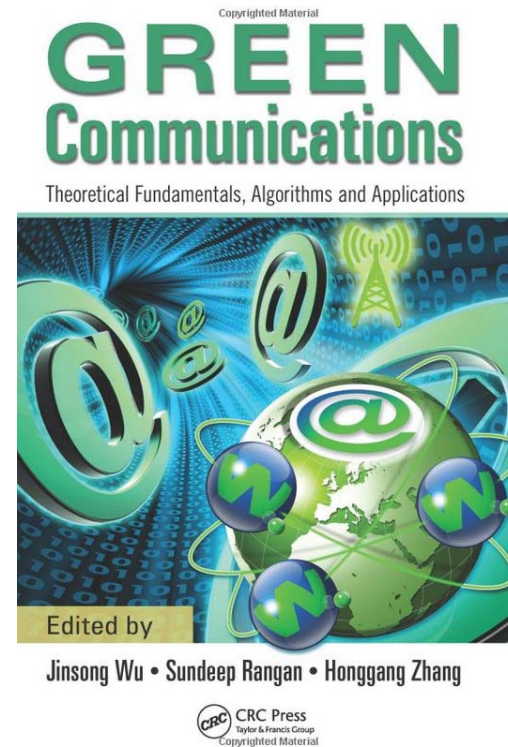
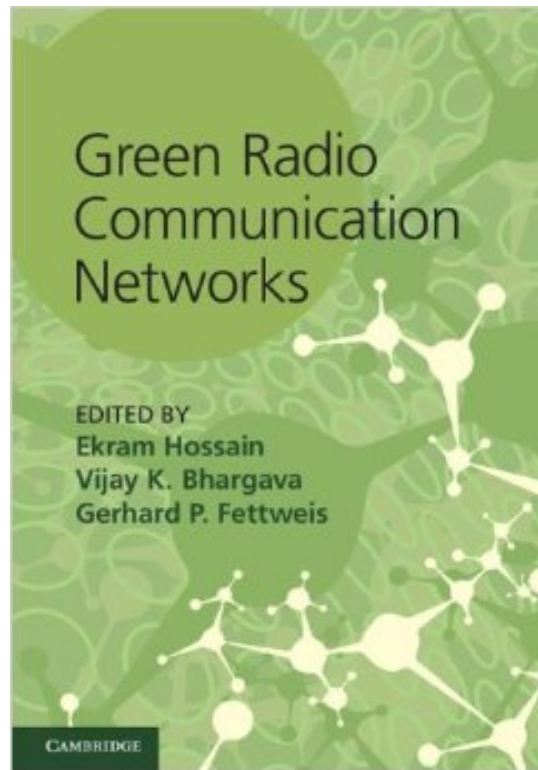

- Edited books containing a number of research articles by different authors
- The subject is at its infancy. More books can be expected to be published



Conclusion

How Much Energy Efficiency Gain Is Achievable?



- Based on the studies quoted, by a careful design of the cellular wireless network and by optimizing its different parts judiciously, two orders of magnitude reduction in energy inefficiency is possible
- This is a substantial figure
- The engineering community and the standards bodies should strive to achieve the maximum possible gain in the face of exponentially increasing traffic
- This has the potential to alleviate the danger of more damage to our environment due to the release of substantial amounts of greenhouse gases



Opportunity to Make Impact: Now



5G?

- Telecommunications industry is beginning to discuss the Fifth Generation (5G) cellular wireless technology
- It is expected that the deployment of this technology will begin in 2020
- What 5G will be is under discussion
- Service providers realize the importance of energy efficiency in next generation cellular technology
- Now is the time to pursue research and try to make an impact in this new standard, soon to be in the making



What Was Not Discussed?



- Will these techniques be implemented? If no, why not? If yes, how?
- Are the costs for e.g., new power amplifiers or massive MIMO justifiable?
- Is the added complexity sufficient to make up for the reduction in energy inefficiency?
- What is the dynamic behavior, e.g., delay or stability of mobility-based algorithms such as sleep modes?
- What are the QoS impacts of the algorithms
- Under what scenarios the algorithms become beneficial and which scenarios make them nonbeneficial?



Energy and Spectral Efficiency in Multi-Cell Heterogeneous Networks



Increase in ICT Electricity Consumption

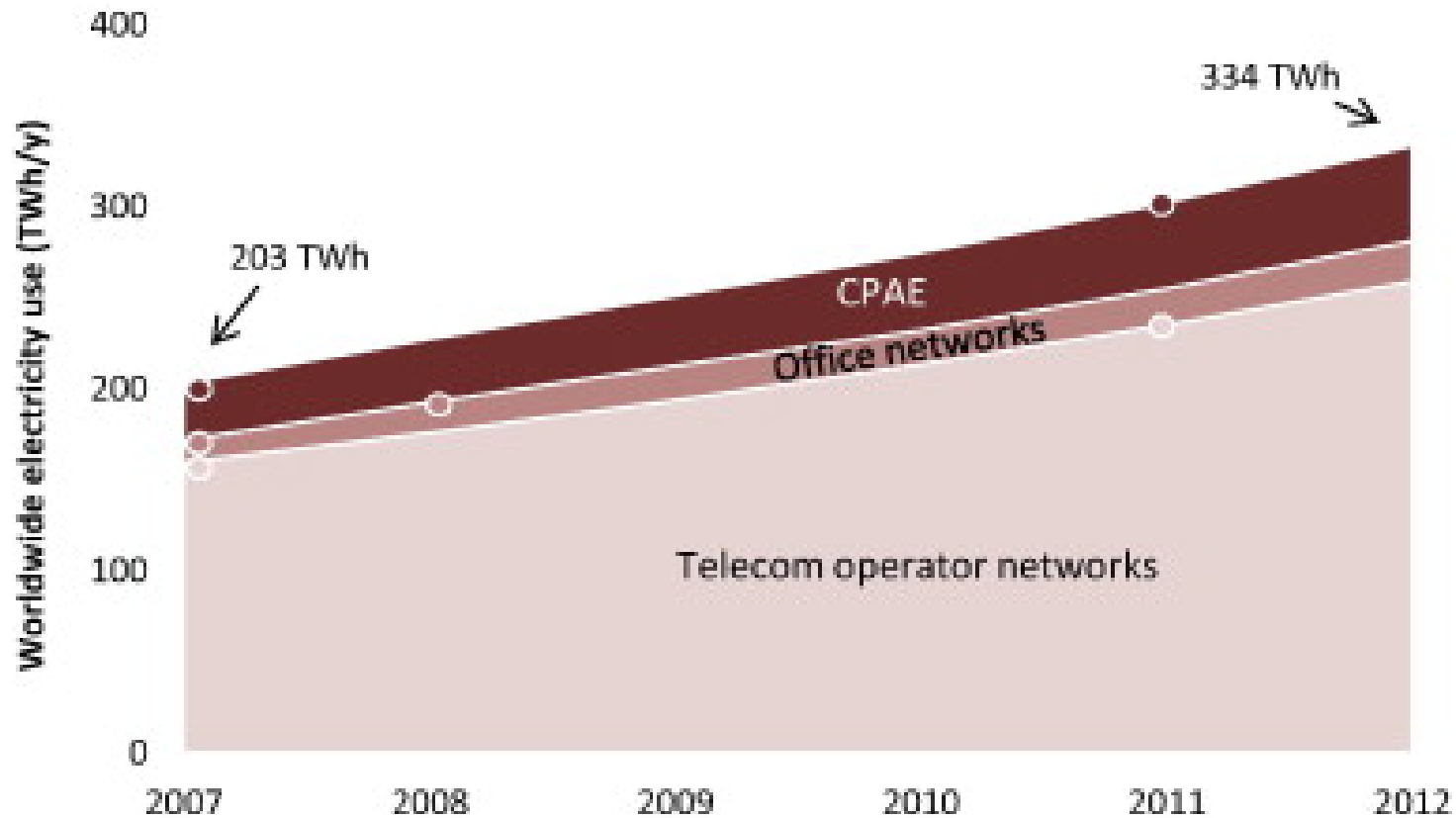

CPAE: Customer Premises Access Equipment

Van Heddegem et al., "Trends in worldwide ICT electricity consumption from 2007 to 2012"

Global Cellular Wireless Traffic

2007-2012, 2016-2021

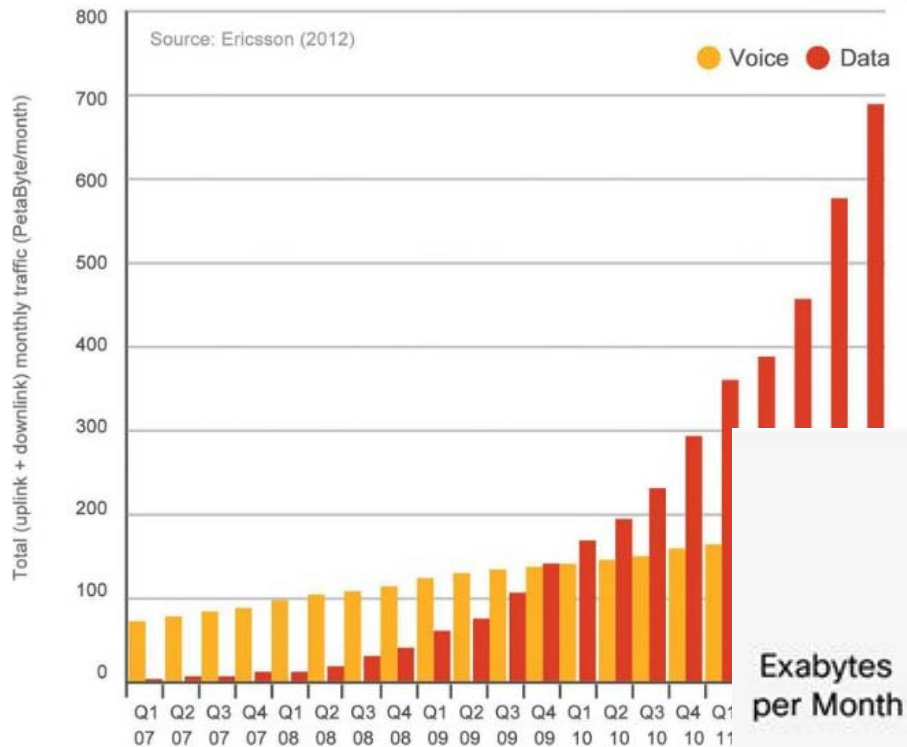

Cellular wireless traffic has grown and will grow exponentially!

<http://www.cisco.com/c/en/us/solutions/collateral/service-provider/visual-networking-index-vni/mobile-white-paper-c11-520862.html>



Question the Vision

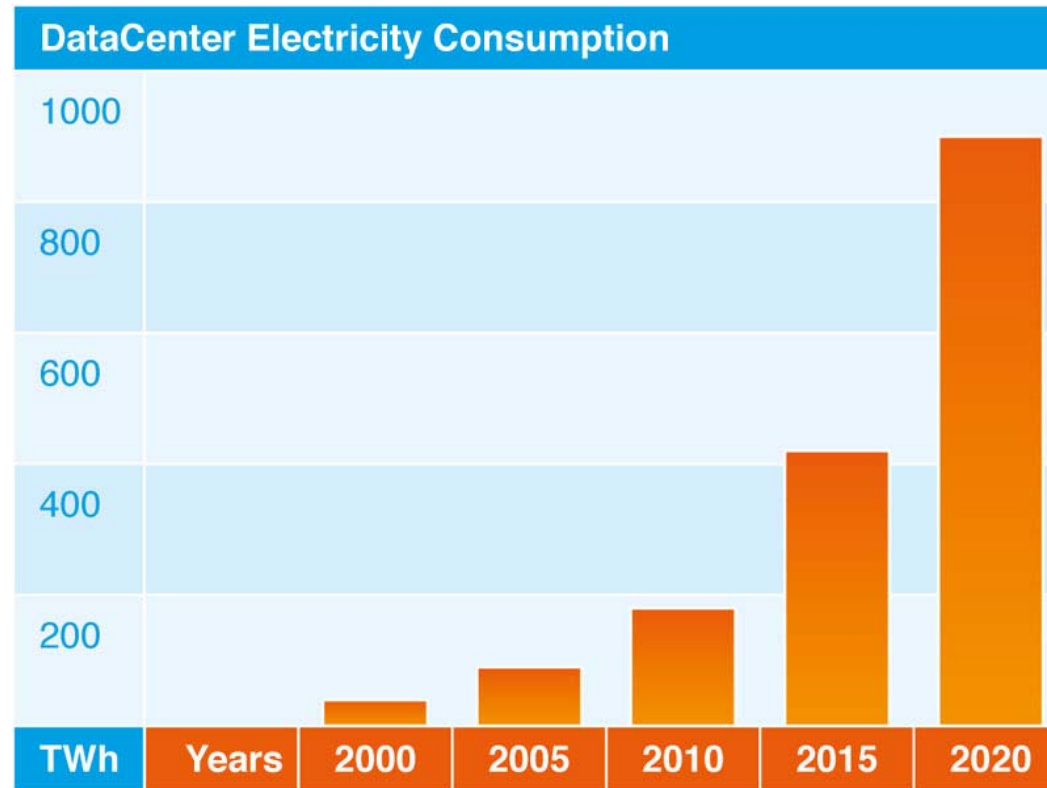

- Today with 5B devices connected to the Internet, data centers consume 4% of all electricity. With IoT vision, the number of devices will increase 10-fold, more processing will be done in the backbone. Do we have 10 times (40%) more energy to give to IoT?



Why Energy Efficiency?

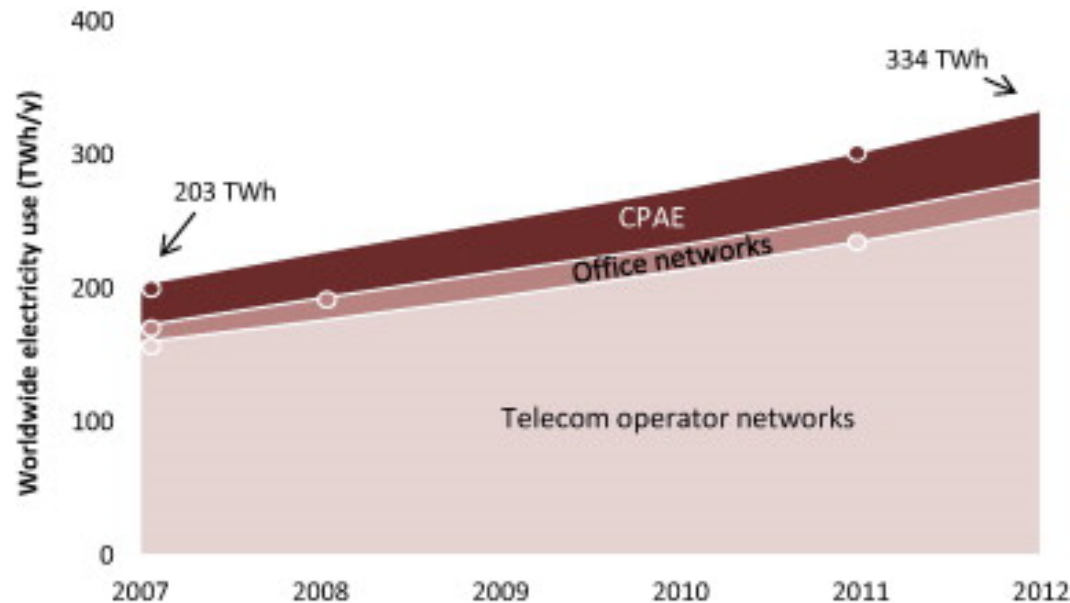

- The total worldwide electricity consumption of communication networks are growing.
- The increased energy consumption in wireless network contribute to the growth of greenhouse gases.
- Why do we want to improve the **Energy Efficiency** ?
 - Decrease the greenhouse gases producing
 - Decrease the operational expenditures



Goals in This Presentation

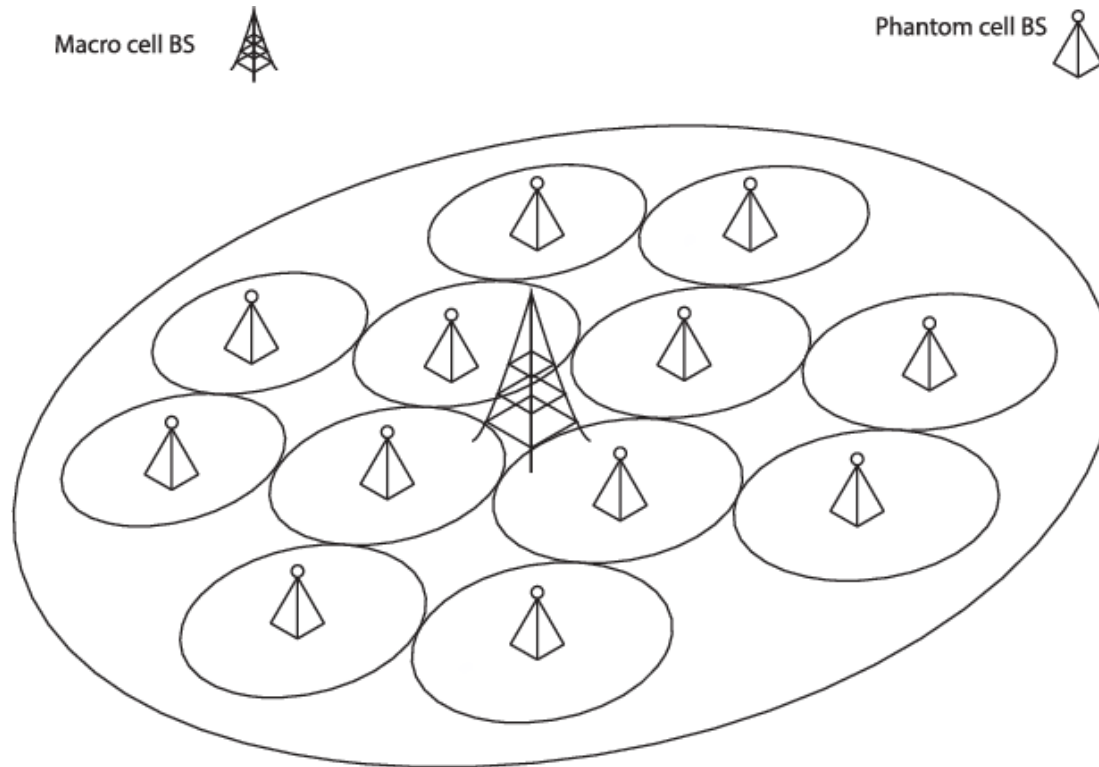

- Spectral efficiency and energy efficiency in multi-cell heterogeneous networks
 - Maximize energy efficiency
 - Maximize spectral efficiency
 - Satisfy minimum rate requirements of users

What is to Come?

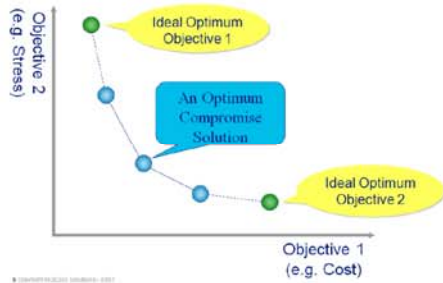

(a)

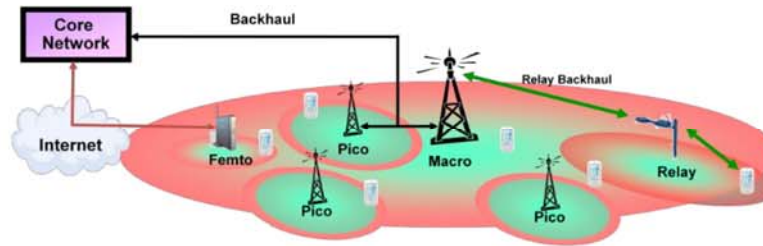

(b)

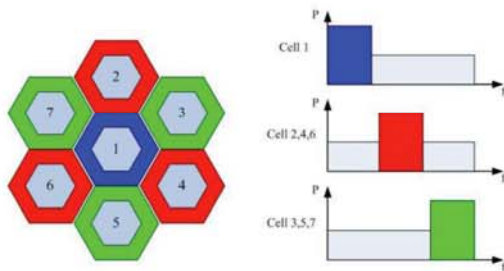

(c)

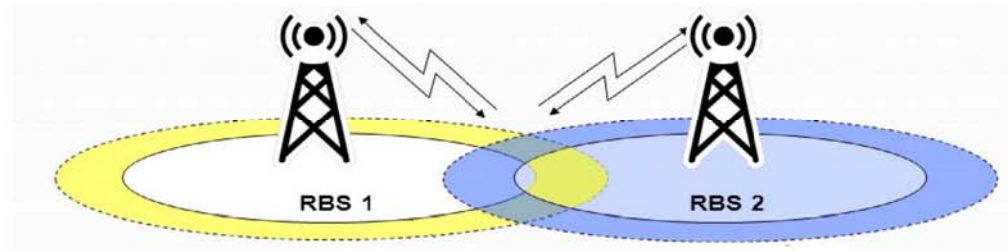

(d)

Figure 6: Multi-Objective Optimization (a), Heterogeneous Networks (b), Interference cancellation and mitigation techniques (c), Power Control Algorithm (d)



Multi-Objective Optimization

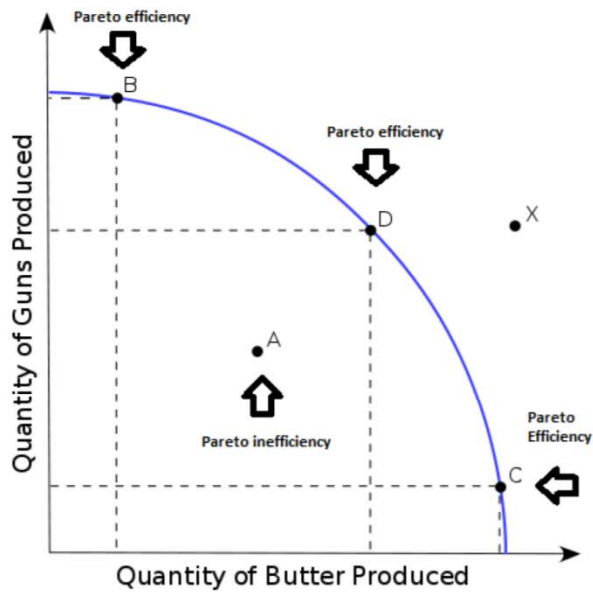

(a)

$$F(x) = \sum_{i=1}^k w_i f_i(x)$$

(b)

$$\tilde{u}(x) = \prod_{i=1}^L x_i^{\lambda_i},$$

(c)

Figure 2: Pareto optimality (a), **Weighted summation** (b), Cobb-Douglas Production Method (c)



Interference Cancellation and Mitigation



- In an interference dominated region, increasing the transmit power slightly improves the throughput, but it significantly degrades the energy efficiency.
- To reduce intercell interference, several interference cancellation and mitigation techniques have been investigated.
 - Fractional Frequency Reuse
 - Interference Cancellation Techniques
 - Beamforming

Fractional Frequency Reuse

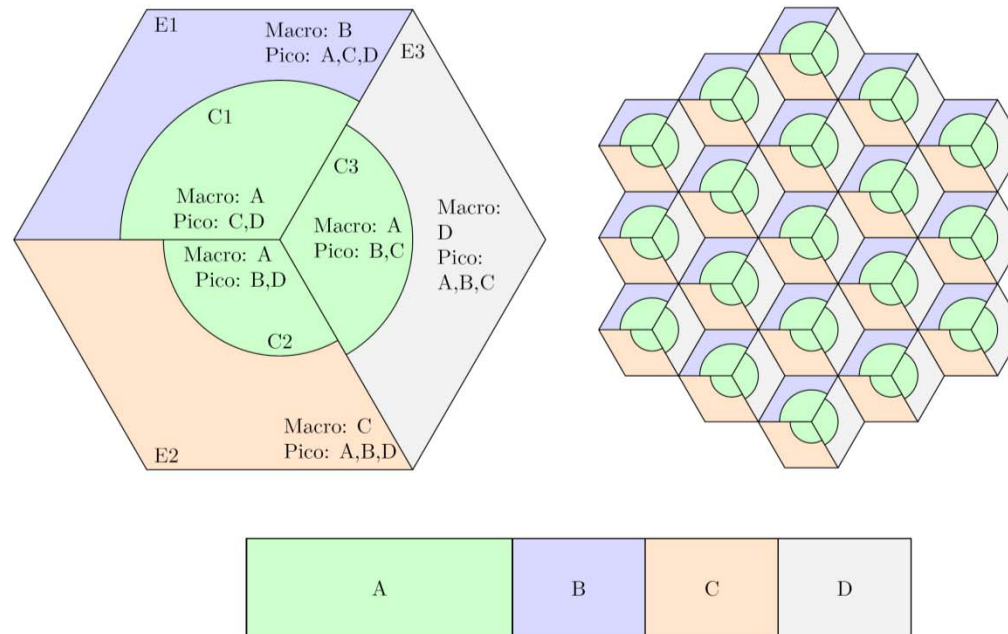

Figure 7: Dynamic cell-center region boundaries and spectrum assignments in a multi-tier FFR scheme. The network layout assumes a uniform 19 cell hexagonal grid in which the MeNBs have three sector antennas and pico-eNBs employ omnidirectional antennas.

β : The parameter scales the aggregate transmit power of base stations.

ε : The parameter adjusts the macrocell transmit power ratio of the cell-edge users to the cell-center users per subcarrier

ε is only defined for MBSs.

System Model



The SINR of cell-center macrocell associated user k at over subcarrier n can be defined as

$$\gamma_k^{(n)} = \frac{P_m^{(n)} g_{k,m}^{(n)}}{\sum_{\substack{m' \neq m, \\ m' \in \mathcal{B}_M}} P_{m'}^{(n)} g_{k,m'}^{(n)} + \sum_{p \in \mathcal{B}_P} P_P^{(n)} g_{k,p}^{(n)} + N_0 \Delta_f}$$

$$P_M = \frac{\beta_M P_{\max, M}}{N_A + \varepsilon_s N_B},$$

- $P_M^{(n)}$: The downlink transmit powers of macrocell M and on subcarrier n
- $P_P^{(n)}$: The downlink transmit powers of picocell P on subcarrier n
- $g_{k,m}^{(n)}$: The channel gain between user k and base station m on subcarrier n
- $\mathcal{B}_M^{(n)}$: The set of MeNBs operating on subcarrier n
- $\mathcal{B}_P^{(n)}$: The set of pico eNBs operating on subcarrier n
- N_0 : The thermal noise power per Hz
- Δ_f : The bandwidth of a subcarrier (15 kHz for LTE systems)

System Model



$$R_s = \sum_{k \in \mathcal{K}_{M,s}} (\mathbf{C}_{M,s}^k \mathbf{F}_{M,s}^{(k,:)} \mathbf{R}_1^{(:,k)} + (1 - \mathbf{C}_{M,s}^k) \mathbf{F}_{M,s}^{(k,:)} \mathbf{R}_2^{(:,k)}) \\ + \sum_{k \in \mathcal{K}_{P,s}} (\mathbf{C}_{P,s}^k \mathbf{F}_{P,s}^{(k,:)} \mathbf{R}_3^{(:,k)} + (1 - \mathbf{C}_{P,s}^k) \mathbf{F}_{P,s}^{(k,:)} \mathbf{R}_4^{(:,k)}).$$

$\mathbf{C}_{M,s}$: whether MUE is in the cell center or not

$\mathbf{C}_{P,s}$: whether PUE is in cell center or not

$\mathbf{F}_{M,s}$: whether the subcarrier n is assigned to user k or not

$\mathbf{F}_{P,s}$: whether the subcarrier n is assigned to user k or not

$$\mathbf{R}_i^{(n,k)} = \Delta_n \log_2 \left(1 + \gamma_k^{(n)} \right), \quad \text{for all } i \in 1, 2, 3, 4,$$

Power Consumption Model



The power consumption model of Macro-BSs and Pico-BSs can be characterized as

$$P_{Macro} = N_{TRX,M} (P_{0,M} + \Delta_M P_{TX,M})$$

$$P_{Pico} = N_{TRX,P} (P_{0,P} + \Delta_P P_{TX,P})$$

Table 1: Base Station Power Consumption Model Parameter Values ¹

Base Station Type	P_0 (W)	P_{sleep} (W)	P_{max} (W)	Δ
Macro-BS	130	75.0	20	4.7
Pico-BS	56	39.0	6.3	2.6

The total power consumed in sector s

$$\psi_s(\varepsilon_s, \beta_s) = P_{Macro} + \sum_{P \in \mathcal{N}_{Pico,s}} P_{Pico},$$

¹: Auer et al., “How much energy is needed to run a wireless network?,” *IEEE Wireless Communications*, Vol. 18, pp. 40-49, October 2011.

Energy and Spectral Efficiency



The energy efficiency of sector s

$$\eta_s(\boldsymbol{\varepsilon}, \boldsymbol{\beta}) = \frac{R_s}{\psi_s(\boldsymbol{\varepsilon}_s, \boldsymbol{\beta}_s)},$$

The unit of energy efficiency, $\eta_s(\boldsymbol{\varepsilon}, \boldsymbol{\beta})$, is bits/Joule.

The spectral efficiency of the sector s

$$\nu_s(\boldsymbol{\varepsilon}, \boldsymbol{\beta}) = \frac{R_s}{W_s},$$

The unit of spectral efficiency $\nu_s(\boldsymbol{\varepsilon}, \boldsymbol{\beta})$ is bits/s/Hz.

W_s : The total bandwidth allocated by MBS and Pico-BSs in sector s .

Optimization Problem



$$\begin{aligned}
 & \max_{\beta, \varepsilon, \mathbf{C}, \mathbf{F}} \sum_{s \in \mathcal{S}} (1 - \alpha) \eta_s(\varepsilon, \beta) + \alpha \frac{W_{tot}}{P_s} \nu_s(\varepsilon, \beta) \\
 & \text{s.t. } \mathbf{C}_{M,s}^k \mathbf{F}_{M,s}^{(k,:)} \mathbf{R}_1^{(:,k)} + (1 - \mathbf{C}_{M,s}^k) \mathbf{F}_{M,s}^{(k,:)} \mathbf{R}_2^{(:,k)} \geq R_{\min,k}, \quad \text{for all } k \in \mathcal{K}_{M,s}, s \in \mathcal{S} \\
 & \quad \mathbf{C}_{M,s}^k \mathbf{F}_{M,s}^{(k,:)} \mathbf{R}_3^{(:,k)} + (1 - \mathbf{C}_{M,s}^k) \mathbf{F}_{M,s}^{(k,:)} \mathbf{R}_4^{(:,k)} \geq R_{\min,k}, \quad \text{for all } k \in \mathcal{K}_{P,s}, s \in \mathcal{S} \\
 & \quad \sum_{\substack{k \in \mathcal{K}_{M,s} \\ \mathbf{C}_{M,s}^k = 1}} \mathbf{F}_{M,s}^{(k,n)} \leq 1 \text{ and } \sum_{\substack{k \in \mathcal{K}_{M,s} \\ \mathbf{C}_{M,s}^k = 0}} \mathbf{F}_{M,s}^{(k,n)} = 0 \quad \text{for all } n \in \mathcal{N}_{M,s}^C, s \in \mathcal{S} \\
 & \quad \sum_{\substack{k \in \mathcal{K}_{M,s} \\ \mathbf{C}_{M,s}^k = 0}} \mathbf{F}_{M,s}^{(k,n)} \leq 1 \text{ and } \sum_{\substack{k \in \mathcal{K}_{M,s} \\ \mathbf{C}_{M,s}^k = 1}} \mathbf{F}_{M,s}^{(k,n)} = 0 \quad \text{for all } n \in \mathcal{N}_{M,s}^E, s \in \mathcal{S} \\
 & \quad \sum_{k \in \mathcal{K}_{M,s}} \mathbf{F}_{M,s}^{(k,n)} = 0 \quad \text{for all } n \notin \mathcal{N}_{M,s}^C \cup \mathcal{N}_{M,s}^E, s \in \mathcal{S} \\
 & \quad \sum_{\substack{k \in \mathcal{K}_{P,s}^p \\ \mathbf{C}_{P,s}^k = 1}} \mathbf{F}_{P,s}^{(k,n)} \leq 1 \text{ and } \sum_{\substack{k \in \mathcal{K}_{P,s}^p \\ \mathbf{C}_{P,s}^k = 0}} \mathbf{F}_{P,s}^{(k,n)} = 0 \quad \text{for all } n \in \mathcal{N}_{P,s}^C, p \in \mathcal{N}_{Pico,s}, s \in \mathcal{S} \\
 & \quad \sum_{\substack{k \in \mathcal{K}_{P,s}^p \\ \mathbf{C}_{P,s}^k = 0}} \mathbf{F}_{P,s}^{(k,n)} \leq 1 \text{ and } \sum_{\substack{k \in \mathcal{K}_{P,s}^p \\ \mathbf{C}_{P,s}^k = 1}} \mathbf{F}_{P,s}^{(k,n)} = 0 \quad \text{for all } n \in \mathcal{N}_{P,s}^E, p \in \mathcal{N}_{Pico,s}, s \in \mathcal{S} \\
 & \quad \sum_{k \in \mathcal{K}_{P,s}^p} \mathbf{F}_{P,s}^{(k,n)} = 0 \quad \text{for all } n \notin \mathcal{N}_{P,s}^C \cup \mathcal{N}_{P,s}^E, p \in \mathcal{N}_{Pico,s}, s \in \mathcal{S} \\
 & \quad \varepsilon \succeq \mathbf{0} \text{ and } \mathbf{0} \preceq \beta \preceq \mathbf{1},
 \end{aligned}$$

Solution to the Optimization Problem



- The objective function of the problem is non-convex over the power control parameters.
- Optimal solution requires exhaustive search over all possible cell-center radii, frequency assignments, and power levels for all sectors.
- To tackle this problem, we propose the following approach
 - We divide this problem into $|S|$ subproblems.
 - Each sector maximizes its own objective function.
 - To prevent base station to increase transmission power imprudently, we introduce interference pricing mechanism.
- In each sector, following three problems are solved:
 - Setting Cell Center Region Boundaries
 - Frequency Assignment Problem
 - Power Assignment Problem

Proposed Solution



- 1: **Initialize:** $r_{th,s}^{(0,c)} = r_{r,s}/2$ $[\varepsilon_s^{(0)}, \beta_s^0] = [1, \mathbf{1}]$
- 2: **Stage 1:** Each sector determines $r_{th,s}^{t,c-1}$ and $r_{th,s}^{t,c+1}$.
- 3: **for** $n := -1$ to 1 **do**
- 4: **Stage 2:** For cell-center radius $r_{th,s}^{(t,c+n)}$, run the frequency assignment algorithm.
- 5: Calculate the Lagrangian functions, $\mathcal{L}_s^{(n)}$.
- 6: **end for**
- 7: The maximum one is selected for the cell-center radius and the frequency assignments.
- 8: **Stage 3:** Run power control algorithm to determine the power control parameters.
- 9: Go to Step 2 and repeat until the convergence.

Flowchart of the Solution

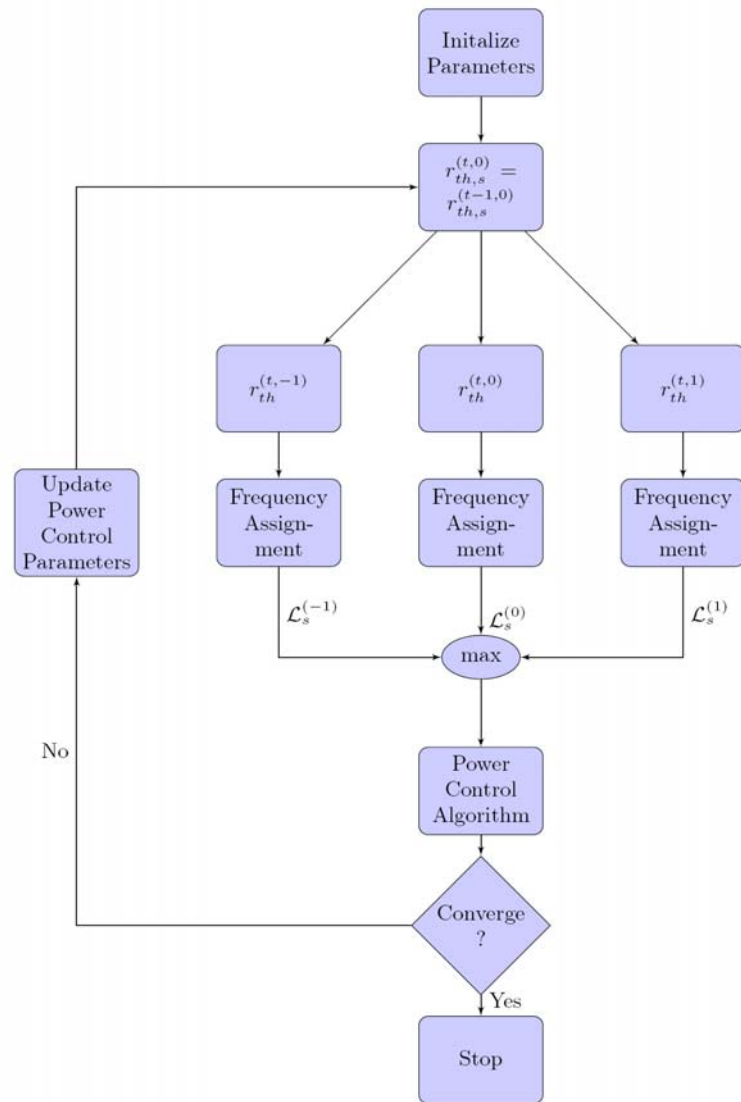

Cell-Center Region Boundaries

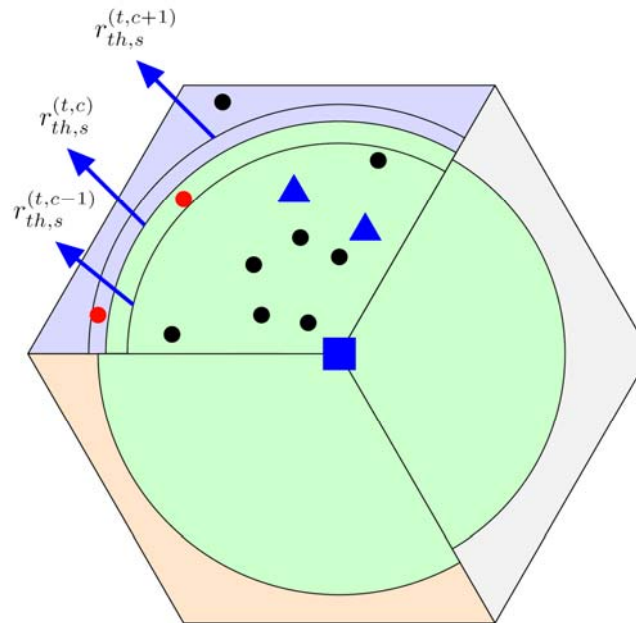

- An iterative algorithm is proposed for cell-center radius selection.
- The proposed algorithm compares the Lagrangian function of the current cell-center radius with two cell-center radii.
 - one more MUE or Pico-BS is included in the cell-center region from the cell-edge region.
 - one more MUE or Pico-BS is excluded to the cell-edge region from the cell-center region.

Frequency Assignment Lagrange-Directed Scheduler



- 1: **Initialize:** $\mathbf{F}_{M,s} = \mathbf{0}$
- 2: $\mathcal{N}_{M,s}^{C,t} = \mathcal{N}_{M,s}^{C,t-1} \cup \mathcal{N}_{M,s}^{C,t-1}$ is the frequency resources that are assigned at time instant $t - 1$.
- 3: First assign one resource block to each user.
- 4: Assign resource blocks to a user that provides the Largest increment in terms of Lagrangian function.

Frequency Assignment Opportunistic Scheduler



- 1: **Initialize:** $\mathbf{F}_{M,s} = \mathbf{0}$
- 2: $\mathcal{N}_{M,s}^{C,t} = \mathcal{N}_{M,s}^{C,t-1} \cdot \mathcal{N}_{M,s}^{C,t-1}$ is the frequency resources that are assigned at time instant $t - 1$.
- 3: $\mathcal{K}_{M,s}^{C,U}$ is the set of users that $\mathbf{F}_{M,s}^{(k,:)} \mathbf{R}_1^{(:,k)} < R_{\min,k}$.
- 4: Assign resource blocks to users until all users in $\mathcal{K}_{M,s}^{C,U}$ satisfy their rate requirement or $\mathcal{N}_{M,s}^{C,t}$ is empty.
- 5: if $\mathcal{N}_{M,s}^{C,t}$ is not empty, assign rest of the resource which has the best average channel gain.

Power Assignment



- 1: **Initialize:** $\mathbf{z}_s^{(t,0)} = (\varepsilon_M^{(t-1, l_{max}+1)} \boldsymbol{\beta}_s^{(t-1, l_{max}+1)T})$ and set $l = 0$
- 2: % Each sector solves Lagrangian Function by using the Levenberg-Marquardt Method
- 3: **for** $l := 1$ to l_{max} **do**
- 4: **if** $\omega_{max} = \max(\text{eig}(\nabla_{\mathbf{z}}^2 \mathcal{L}_s^{(l)})) < 0$ **then**
- 5: $\xi = 0.$
- 6: **else**
- 7: $\xi = \omega_{max} + \sigma.$
- 8: **end if**
- 9: $\mathbf{d}_l^{LM} = -(\nabla^2 \mathcal{L}_s^{(l)} - \xi \mathbf{I})^{-1} \nabla \mathcal{L}_s^{(l)}.$
- 10: Update the power control

parameters, $\mathbf{z}_s^{(l+1)}$, using

$$\mathbf{z}_s^{(t, l+1)} = \mathbf{z}_s^{(t, l)} + \mu_l \mathbf{d}_l^{LM},$$

- 11: Update the Lagrange multipliers, $\lambda_{k,s}^{(l+1)}$ for all $k \in \mathcal{K}_{M,s}$ and $\mathcal{K}_{P,s}$
- 12: **if** $|\nabla \mathcal{L}_s^T \mathbf{d}_l^{LM}| \leq \epsilon$ **then**
- 13: **Break**
- 14: **end if**
- 15: **end for**
- 16: $\mathbf{z}_s^{(t, l_{max}+1)} = (1 - \zeta) \mathbf{z}_s^{(t-1, l_{max}+1)} + \zeta \mathbf{z}_s^{(t, l_{max})}$
- 17: *Price Update:* Each user calculates interference prices and feds these values back to its base station.
- 18: Interference prices are distributed among base stations.

Simulation Setup

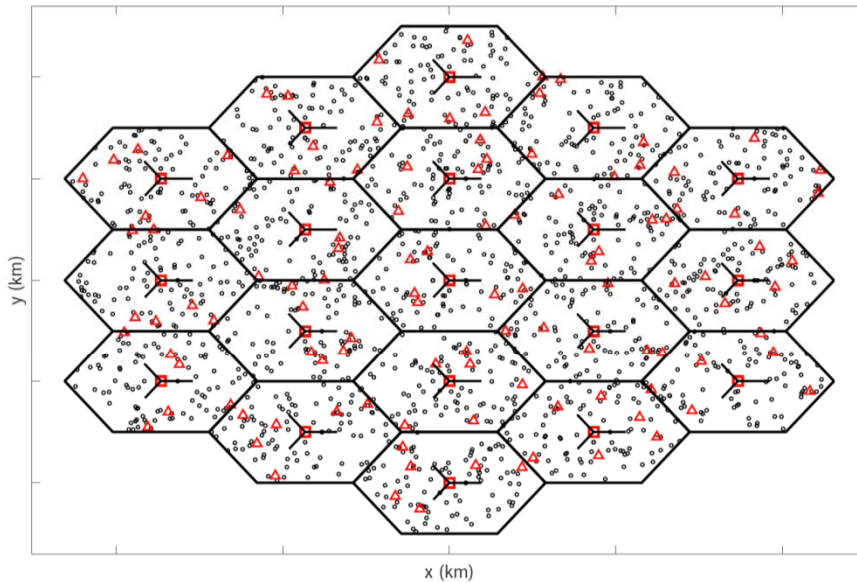

Figure 9: Macro BSs, Pico BSs, and user distribution for a sample scenario.

Table 2: Simulation Parameters

Parameter	Setting
Channel bandwidth	10 MHz
Total number of RBs	50 RBs
Freq. selective channel model (CM)	Extended Typical Urban CM
UE to MeNB PL model	$128.1 + 37.6 \log_{10}(d)$
UE to pico-eNB PL model	$140.7 + 36.7 \log_{10}(d)$
Effective thermal noise power, N_0	-174 dBm/Hz
UE noise figure	9 dB
MeNB and pico-eNB antenna gain	14 dBi and 5 dBi
UE antenna gain	0 dBi
Antenna horizontal pattern, $A(\theta)$	$-\min(12(\theta/\theta_{3dB})^2, A_m)$
Penetration loss, A_m and θ_{3dB}	20 dB, 20 dB, and 70°
Macro- and picocell shadowing	8 dB and 10 dB
Inter-site distance	500 m
Traffic model	Full buffer

Simulation Results: Energy Efficiency Levenberg-Marquardt Algorithm

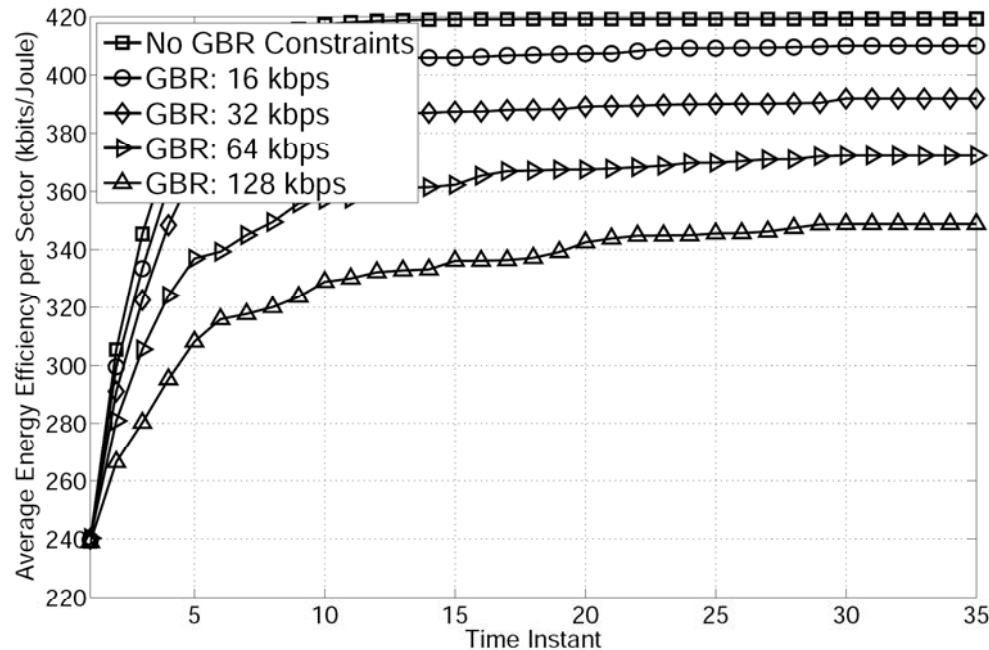

Figure 10: The average energy efficiency per sector for lower GBR requirements of users.

- $\eta(\epsilon, \beta) \downarrow$ while $R_{min} \uparrow$.
- The reduction in $\eta(\epsilon, \beta)$ is marginal due to the fact that the rate constraints of most of the users are already satisfied at the energy-efficient optimum power level.

Simulation Results: Energy Efficiency Higher GBR Rates

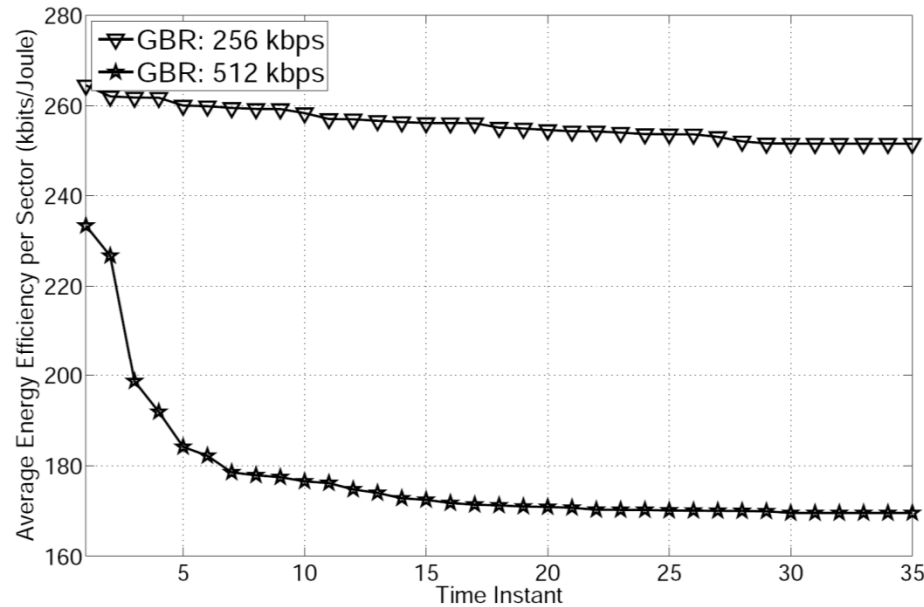

Figure 11: The average energy efficiency per sector for higher GBR requirements.

- $\eta(\epsilon, \beta)$ of the network decreases in each time instant.
- The reason behind that is threefold.
 - MBS increases their transmission power.
 - The intercell interference increases.
 - Pico-BSs decreases their transmission power.

Simulation Results: Average Transmission Power

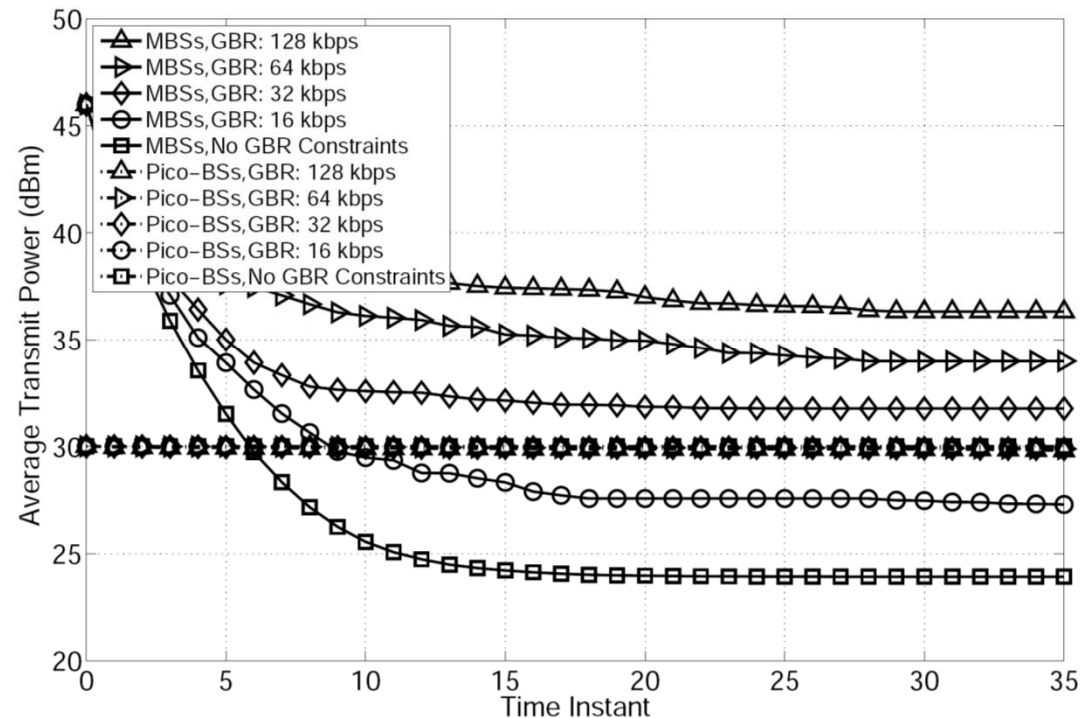

Figure 14: The average transmission power for lower GBR requirements.

- The average transmission power of the MBSs decreases every time instant until the convergence.
- The proposed algorithm provides significant power savings.

Simulation Results: Av. Transmission Power – Higher Rates

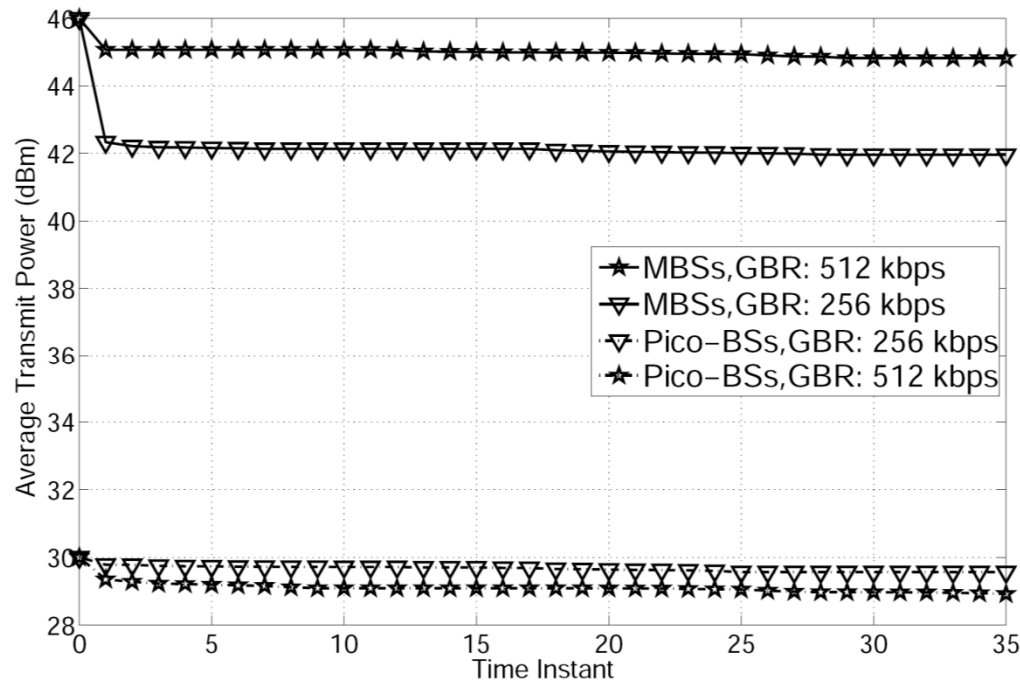

Figure 15: The average spectral efficiency per sector for various GBR requirements of users are depicted for different α values.

- The power savings of the network is significantly lower.
- The decline in the power savings is the main cause of the decrease in energy efficiency.

Simulation Results: Different Schedulers

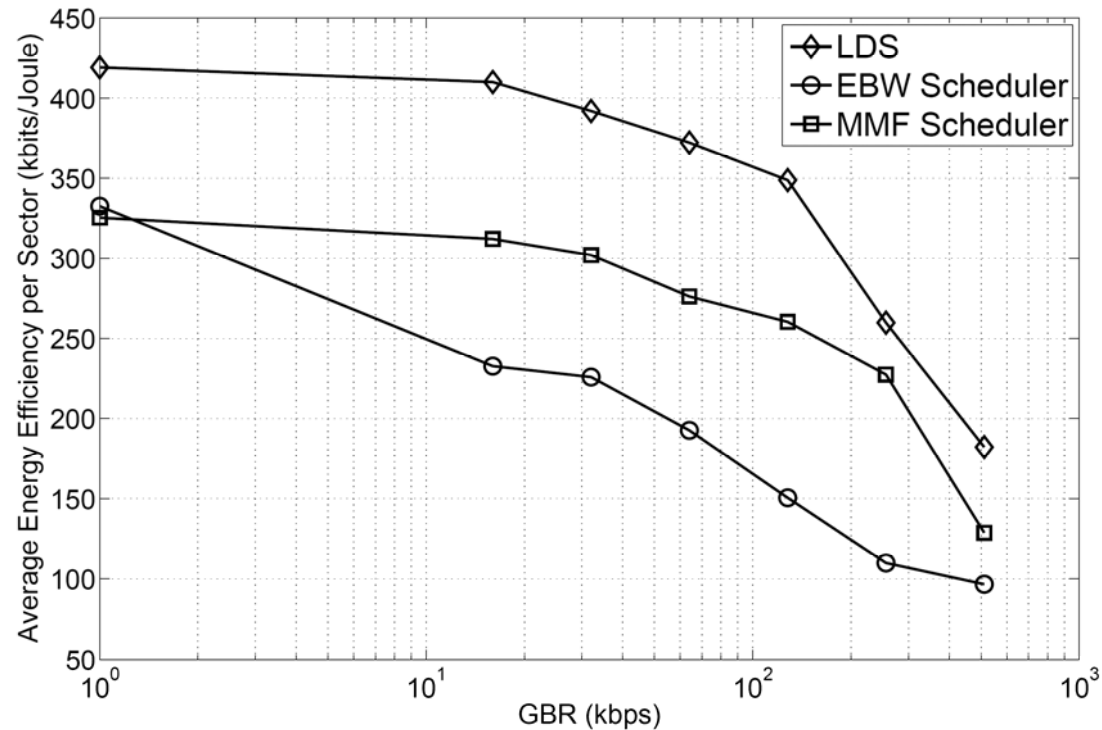
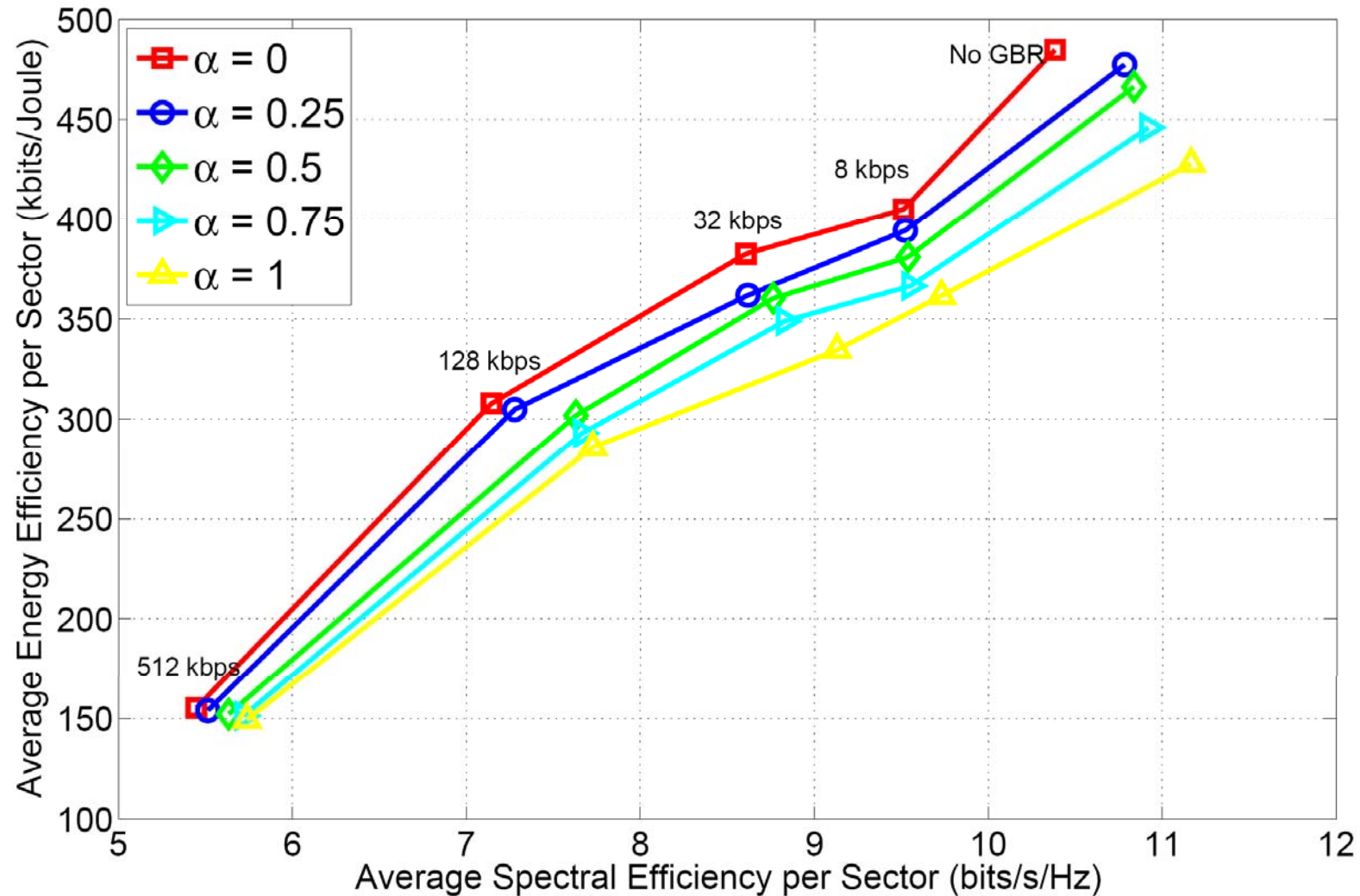

Figure 18: The average energy efficiency per sector for the LDS, EBW, and MMF schedulers.

- The LDS performs significantly better than the other two schedulers for all GBR requirements.

Energy Efficiency vs. Spectral Efficiency Pareto Optimality with α



Simulation Results: Outage Probability

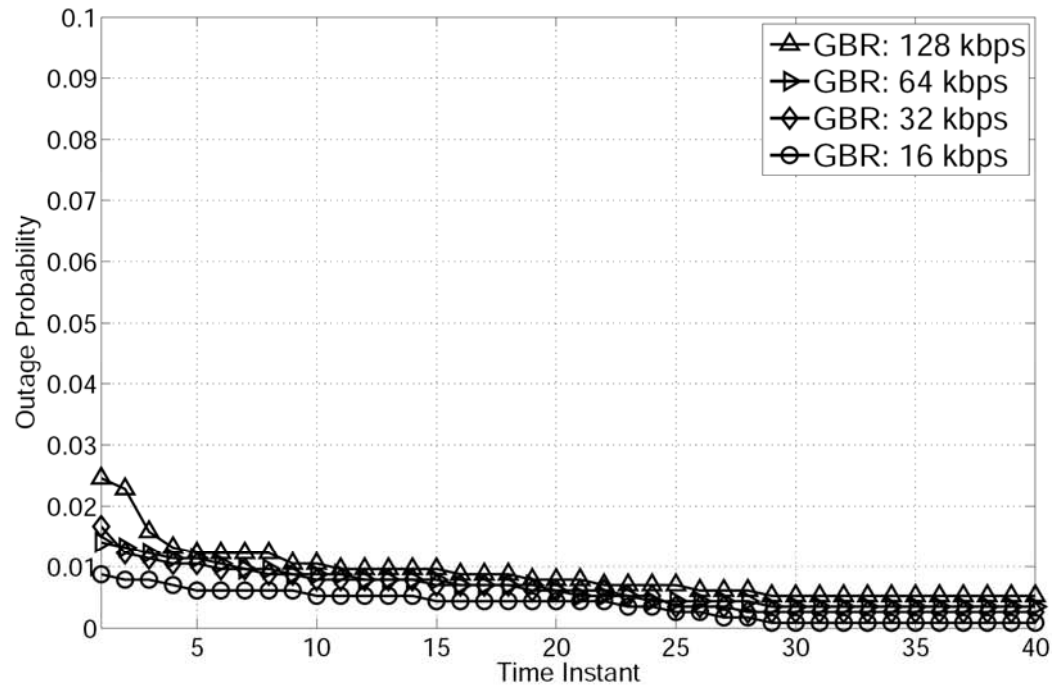

Figure 12: The outage probabilities for lower GBR requirements of users.

- The outage probabilities are very low for these rate constraints.

Simulation Results: Outage Probability – Higher Rates

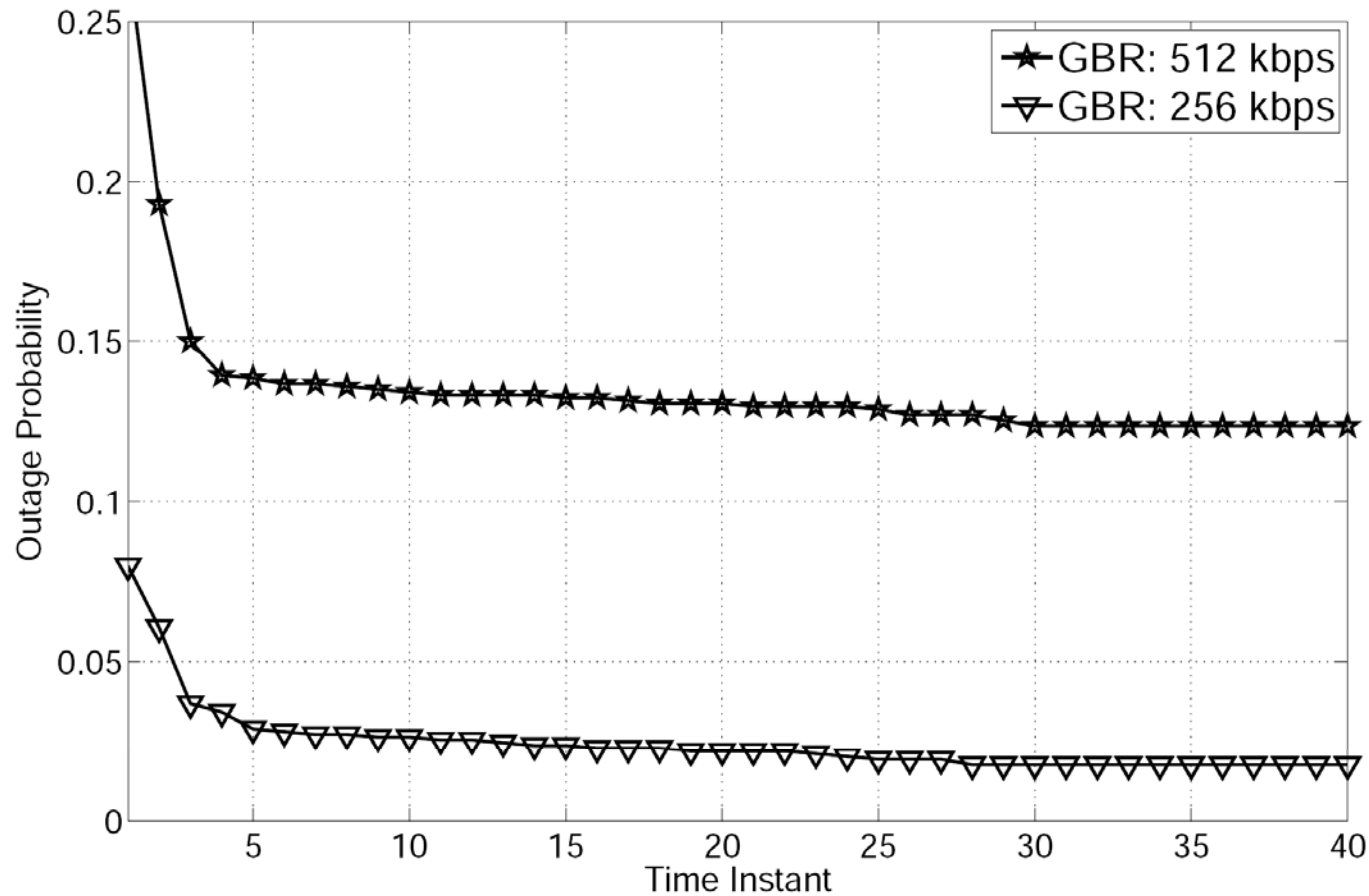

Figure 13: The outage probabilities for higher GBR requirements of users.

Conclusions



- The energy efficiency and spectral efficiency in multi-cell heterogeneous wireless networks is investigated in this presentation.
- The trade-off between energy efficiency and spectral efficiency can be adjusted via the weight of the multi-objective function.
- Increasing spectral efficiency of the network also increases the outage probabilities of the network due to the increased intercell-interference.
- The number of resource blocks that are transmitted can be reduced by increasing the minimum rate constraints or the parameter α .
- While the transmission powers of the MBSs increase with the minimum rate constraints of the users, the transmission power of Pico-BSs decreases.

Energy Efficiency in Data Centers

Basic Data Center Statistics



- Data centers are factories of digital age, mostly windowless, featureless boxes scattered around the globe
- Their construction costs about \$20B a year worldwide
- Biggest, covering 1M ft² consume as a city of 1M people
- In total, they consume more than 2% of the world's electricity
- They emit roughly as much CO₂ as the airline industry
- Can get worse because global data traffic is doubling every four years

Electricity Consumption of Global IT Industry (2012)

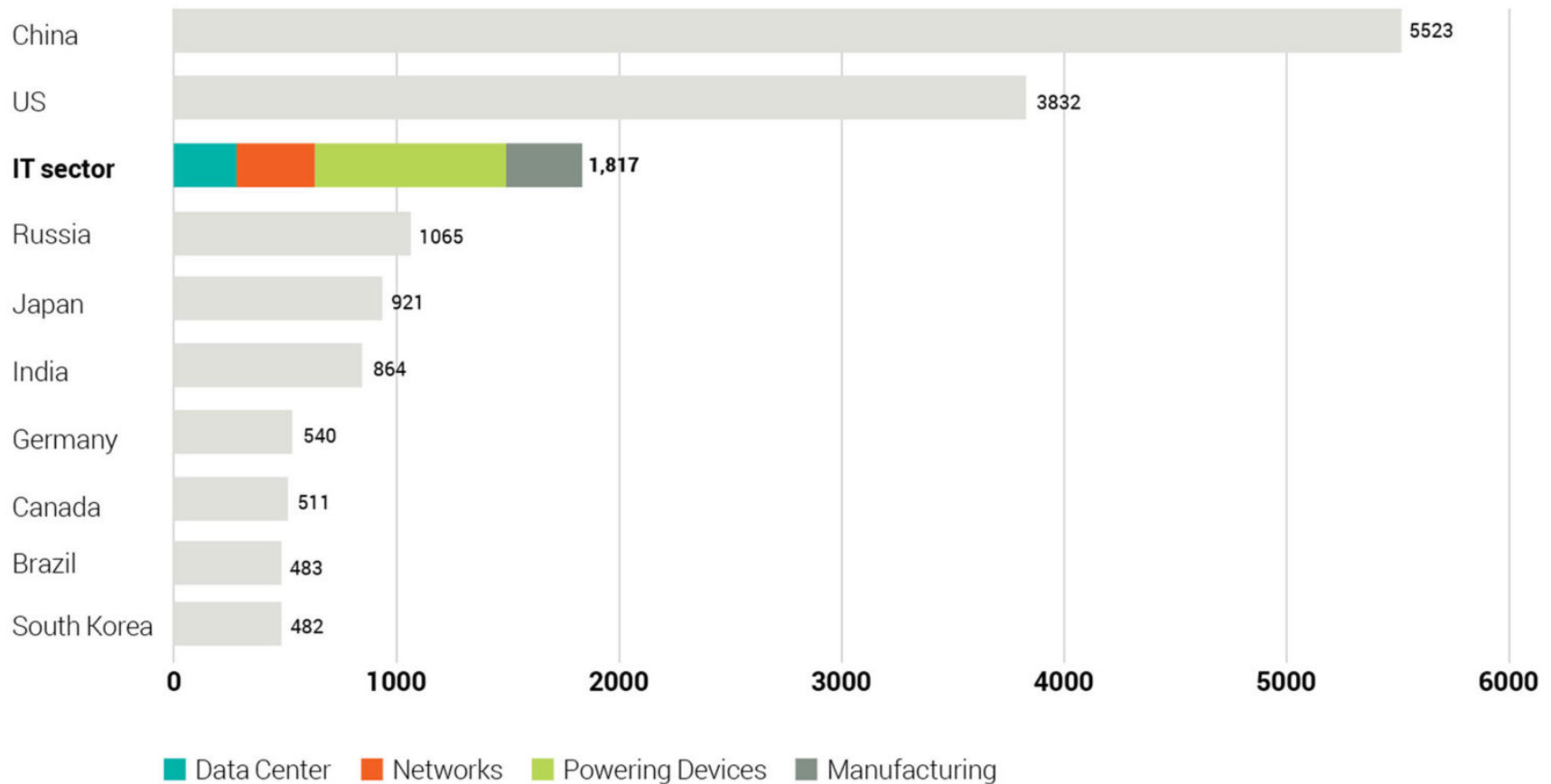

- If the global IT industry were a country, only China and US would contribute more to energy consumption worldwide



Google's Energy Use



- Google's data centers consume 260 MW, $\frac{1}{4}$ of the output of a nuclear plant
- This is sufficient to power 200K homes
- All data centers in the world consume about 2% of the world's electricity
- One Google search is equal to turning on a 60W light bulb for 17 seconds
- One Google search is responsible from emitting 0.2 grams of CO₂
- Google emits 1.46M metric tons of CO₂ per year
- To offset this, Google funds green efforts elsewhere, enough to power 350K homes



Role of Internet Video

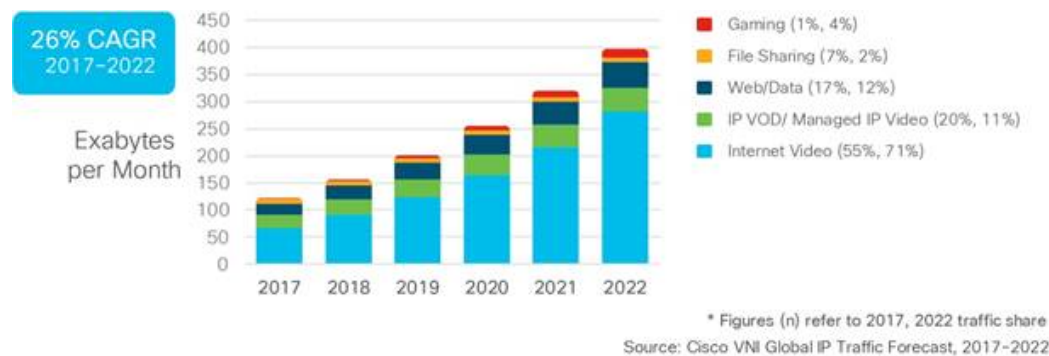
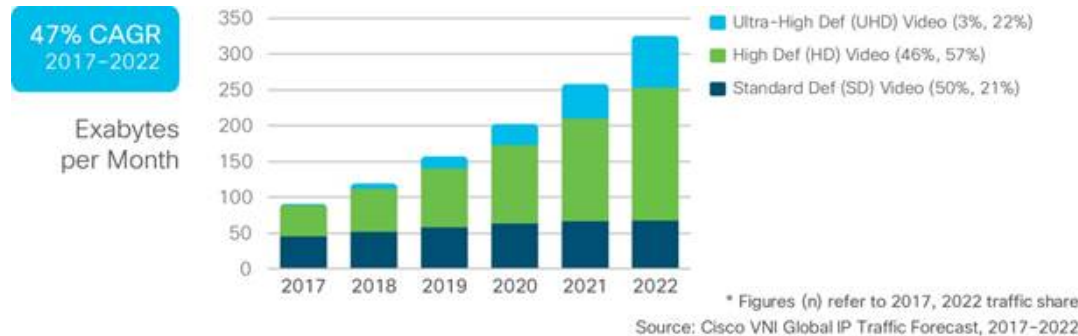

- Streaming video is the most significant part of the global data traffic
- Cisco predicts it will make up 82% of traffic by 2021, up from 73% in 2012
- Currently, around 1/3 of Internet traffic in North America is already dedicated to streaming Netflix services



Netflix and Amazon Web Services



- Netflix is singled out by Greenpeace for substantial energy inefficiency
- It does not own data centers, instead uses contractors such as Amazon Web Services, world's largest cloud computing company
- Greenpeace declared Amazon Web Services as being completely nontransparent about the energy footprint of its massive operations
- AWS has some of its largest operations in Northern Virginia, which has the largest concentration of data centers in the world. Northern Virginia gets less than 3% of its energy from nonrenewable sources, and 33% from nuclear plants
- AWS states it launched a series of wind and solar farm projects to deliver around 40% of its energy



How Much CO₂ is Needed to Generate 1 kWh of Energy?



Greenhouse Gas Emissions from Electricity Production

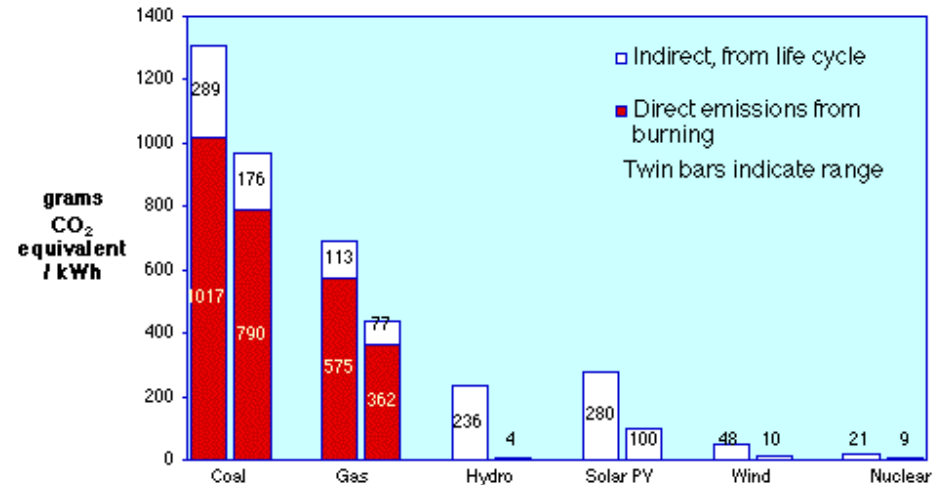

Source: IAEA 2000

- Norway: 3 grams (hydro)
- France: 100 grams
- California: 300 grams
- Virginia: 600 grams
- New Mexico: 800 grams
- Bangalore: 900 grams (home of Tulip's giant data center)
- Most of this energy is used to keep processors cool
- Most of the world's largest data centers are in hot or temperate climates
- Sadly, of the world's 10 largest, two are in Nevada, others are in Georgia, Virginia, and Bangalore



Power Use Effectiveness (PUE)



- Defined as the ratio of the total amount of energy used in the center by the amount needed to run the processors
- Smaller PUE is better (smaller energy used for operations other than running the processors)
- An industry analysis a decade ago found an average PUE of 2.5
- Best practice PUE was deemed to be around 1.6
- A study published recently on European data centers found 1.8
- Google claims 1.12



Google data center in Dalles, OR (Columbia river)



Microsoft's Underwater Data Center

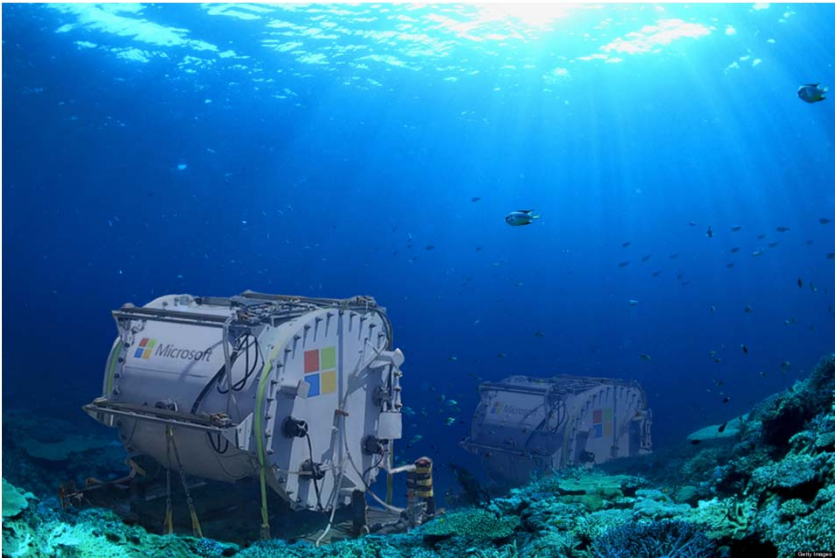

How Much Are Data Centers Consuming?



- Report published in 2016 by Lawrence Berkeley National Laboratory for the U.S. Department of Energy
- It estimated that improved energy is now almost canceling out growing capacity
- In 2014, U.S. data centers used 70B kWh
- The estimate for 2020 is 73B kWh
- If energy efficiency levels remained as they were in 2010, the number would be close to 160B kWh



What Can Be Done to Reduce Energy Consumption in Data Centers?



- Decommission or repurpose servers which are no longer in use
- Power down servers when not in use
- Enable power management
- Replace inefficient servers
- Virtualize or consolidate servers



The logo features a central square with a teal-to-gold gradient background. A stylized sunburst of gold rays emanates from the bottom. Two white curved lines, resembling orbits or paths, cross the square. The text "Engineering the Future at" is centered in white, with "UCLA Irvine" below it in a larger, bold white font.

Engineering the Future at

UCLA Irvine